



inVENTer



Operating Instructions inVENTer Connect



Controller platform



Trademarks, copyrights and property rights

inVENTer® is a registered trademark of inVENTer GmbH.

The copyright to this document remains with the manufacturer.
Rights to all content and images: © inVENTer GmbH 2021.

All trademarks used in this document are the property of their respective manufacturers and are hereby acknowledged.

Disclaimer

This documentation represents an translation of the original operating instructions.
The information on access to the operating instructions must be passed on to third parties when the system is handed over.

The content of this documentation has been checked for compliance with the described components. Nevertheless deviations may still occur, therefore no guarantee of compliance can be provided.

This documentation describes the functionality of the standard scope. For reasons of clarity, the documentation does not purport to cover all details on all types of the product and cannot cover every conceivable scenario for commissioning, operation, cleaning and care.

The illustrations in this document may differ slightly from the design of the product that you have purchased. The same functionality is ensured despite any design deviations.

This documentation is updated regularly. Necessary corrections and appropriate supplements are always included in subsequent editions. You can find the latest version at www.inventer.de/downloads.

Company information

Publisher:

| | | |
|---------------------|---------|--|
| inVENTer GmbH | Phone: | +49 (0) 36427 211-0 |
| Ortsstraße 4a | Fax: | +49 (0) 36427 211-113 |
| D-07751 Löberschütz | E-mail: | info@inventer.de |
| Germany | Web: | www.inventer.de |

CEO: Annett Wettig
VAT ID number: DE 815494982
Jena District Court HRB 510380

Table of contents

| | | |
|----------|---|-----------|
| 1 | User and safety instructions | 4 |
| 1.1 | User information | 4 |
| 1.2 | Safety instructions | 5 |
| 2 | System overview | 7 |
| 2.1 | Easy Connect e16 controller (incl. humidity/temperature sensor) | 7 |
| 2.2 | Connect inner cover | 9 |
| 2.3 | Sensor technology | 10 |
| 2.4 | "inVENTer Mobile" app | 13 |
| 3 | Operation and set-up on the controller | 14 |
| 3.1 | General information | 14 |
| 3.2 | Initial setup of the controller | 18 |
| 3.3 | Pairing of system components | 23 |
| 3.4 | Selecting ventilation zones / Showing the status of ventilation zones | 29 |
| 3.5 | Changing the fan settings | 31 |
| 3.6 | Activating the boost / pause function globally | 36 |
| 3.7 | Activating the boost / pause function by zone | 40 |
| 3.8 | Acknowledging warnings / notifications | 44 |
| 3.9 | Resetting the controller and devices | 46 |
| 4 | Operation and setup with the app | 48 |
| 4.1 | Adding the controller to the app | 48 |
| 4.2 | The screen of the app | 50 |
| 4.3 | "Device overview" menu | 51 |
| 4.4 | Device identification | 53 |
| 4.5 | Renaming components | 53 |
| 4.6 | Changing the direction of rotation of the fan | 54 |
| 4.7 | Assigning devices to the ventilation zones | 55 |
| 4.8 | Defining ventilation zones and their properties | 56 |
| 4.9 | Advanced settings | 63 |
| 4.10 | Setting the device as a signal amplifier (repeater function) | 81 |
| 5 | Cleaning and care | 85 |
| 5.1 | Easy Connect e16 controller | 85 |
| 5.2 | Connect inner cover | 86 |
| 5.3 | Sensor technology | 90 |
| 6 | Accessories and spare parts | 93 |
| 7 | Troubleshooting and disposal | 94 |
| 8 | Warranty and guarantee | 97 |
| 9 | Service | 97 |
| | Annex | 98 |
| | Ventilation profiles (time intervals of the factory setting) | 98 |
| | Automatic ventilation profiles | 101 |

1 User and safety instructions

1.1 User information

Safety and warning instructions

The safety instructions in these operating instructions have a uniform structure and are marked with a symbol on the left side of the instruction. A signal word above the text also indicates the hazard level. If several hazard levels exist, the highest level safety instruction is always used.

The safety and warning instructions contain the following information:



SIGNAL WORD:

Type and origin of the hazard. Possible consequences of the hazard!
Measures to avoid the hazard.

The signal word indicates the severity of the potential hazard unless the preventive measures are taken:



DANGER means: Immediate danger of serious injury or death.



CAUTION means: Potential risk of mild / moderate physical injury or death.



NOTICE means: Direct or possible risk of property damage due to an adverse event/state.

If you see these signs, ensure you observe the described measures to prevent possible hazards and/or damage.

Other symbols and notices used in this documentation

In addition to the safety instructions, the following symbols are used:



A **TIP** symbol indicates practical and useful tips for handling the devices on the inVENTer Connect controller platform.



Before each step, any additional tools and materials required for the task are listed.



Red bar over a graphic: graphic shows the interior wall.



Blue bar over a graphic: graphic shows the exterior wall.



Action required: This prompts the user to perform a specific action.



Check the results requires you to check the results of the action you have performed.



Book: refers to another section in this documentation.

Action focus: To be taken into account in the corresponding step.



Scroll: Operating option within the "inVENTer Mobile" app.



By swiping across the screen (horizontally: or vertically:), you can scroll through selection and setting screens, e.g. ventilation profiles.

1.2 Safety instructions

The operating instructions are part of your inVENTer Connect controller platform and must be available at all times (see www.inventer.de/downloads). When handing the system to a third party, the information regarding access to the operating instructions must be handed over also.

Before performing any work on the system, read the operating instructions carefully and observe all information in this section regarding commissioning, operation, cleaning and care. Also note the safety instructions that precede the described handling instructions.

Non-observance of safety instructions could result in injury and/or property damage.

Intended use

The inVENTer Connect controller platform may only be used to control the decentralised iV ventilation units with heat recovery (iV-Smart+, iV14-Zero, iV-Light or iV-Compact product series, each equipped with the Connect inner cover) from inVENTer GmbH.

Specifically, the following must be used:

- The Easy Connect e16 controller to control the devices included in the system.
- The Connect inner cover controlled by the controller to control the inVENTer ventilation units with heat recovery.
- The sensor system is paired to the controller (FTS19-Connect Indoor/Outdoor humidity/temperature sensor, CS2-Connect CO₂ sensor and SK19-Connect switching contact) to supply temperature, humidity and CO₂ values to the controller, which in turn uses these values to control the inVENTer ventilation units with heat recovery.

Requirements for intended use:

- Use the units integrated into the ventilation system only in accordance with the applications that are described in this documentation and only in conjunction with devices that are recommended, approved and named by inVENTer GmbH in this documentation. Changes or modifications to the devices are not permitted.
- In particular, use the FTS19-Connect Indoor humidity/temperature sensor exclusively to measure the humidity and temperature of indoor air, the FTS19-Connect Outdoor humidity/temperature sensor to measure the humidity and temperature of outdoor air, the CO₂ sensor exclusively to measure the carbon dioxide content as well as the temperature and humidity of indoor air and the SK19-Connect switching contact exclusively to integrate safety devices while simultaneously operating the ventilation system with fireplaces and all four only in conjunction with the Easy Connect e16 controller. Changes or modifications to sensors and switching contacts are not permitted.
- Proper operation and maintenance are required for trouble-free and safe operation of the system.
- These operating instructions are **only valid in conjunction with the installation and operating instructions of the corresponding ventilation device** with Connect compatibility and supplement these. All legal notices that are listed in the respective installation and operating instructions also apply without restriction to this document.
- All devices integrated into the inVENTer Connect controller platform comply with technical safety requirements and standards of electrical devices. The controller platform may only be set up and operated in conjunction with this documentation.



- **CAUTION:**

The inVENTer Connect controller platform must not be commissioned for the first time, operator or cleaned by children and/or persons who are not able to do so safely due to their physical, sensory or mental abilities, inexperience or lack of knowledge, unless they are supervised by a person responsible for their safety or have received instructions from them on how to operate the system. Small children must be supervised to ensure that they do not play with the system's devices.



- **NOTICE:**

If the locking arm of the inner cover is in the wrong position, the locking arm can break off. Before the closing flap is (re-)fitted, the locking arm must be swivelled to the right. This is done exclusively using the Easy Connect e16 controller or the "inVENTer Mobile" app. To do this, switch all devices to pause (📖 3.6: Boost/Pause or when operating via app 📖 4.2 | 4.8: Set ventilation mode and level). Never swivel the locking arm by hand!

Any kind of use other than the intended use will exclude all liability claims.

Unintended use

The inVENTer Connect controller platform is intended exclusively for the control of the ventilation devices specified in the section on intended use. Any other use is strictly prohibited.

2 System overview

The inVENTer Connect controller platform is an innovative control system for decentralised iV ventilation units with heat recovery featuring the use of the Connect inner cover from inVENTer GmbH.

Up to 16 devices can be integrated into the inVENTer Connect controller platform.

Communication between the control unit and the devices takes place:

- wirelessly via the RF868 MHz network or
- via a RS485 data cable.

The inVENTer Connect controller platform can be assembled with the following devices, depending on individual requirements:

2.1 Easy Connect e16 controller (incl. humidity/temperature sensor)

The Easy Connect e16 controller (in the following text "controller") is the control centre for the inVENTer Connect controller platform. It is used to control and program the individual devices.

The controller has a display screen and keys for quick access, making it possible to use it as a programming unit.



The controller also serves as the system interface for the "inVENTer Mobile" app (Android / iOS). Communication between the mobile device and the controller takes place via Bluetooth Low Energy (BLE).

There are two ways to operate the inVENTer Connect controller platform:

- Directly via the controller;
- Via the "inVENTer Mobile" app in conjunction with the controller.

In order to be able to use the full range of functions of all devices in the system in the best possible way, we recommend operating and configuring the controller via the "inVENTer Mobile" app.

The capacitive sensor keys available on the programming unit can be used to make quick settings for the ventilation system.

The status display (LED, multi-coloured) shows the status of the controller by means of lights in various colours (📖 3.1: Controller operation, General).

The mode key can be used to trigger system configurations. The different actions are triggered by holding the mode key for different lengths of time.

The display screen shows all the information about the ventilation system (ventilation system in normal operation) or, when changing/manually overriding settings that determine function-defining settings, setting screens are displayed.

Function

After installation and connection to the power supply, the controller starts with the factory settings and the display screen shows the room temperature and humidity, which are transmitted by the sensor integrated into the controller.

The desired devices can then be paired with the controller and thus integrated into the ventilation system (📖 3.3: Pairing), as well as be set up.

The display screen first shows the number of paired devices. When pairing is complete, the display screen shows the corresponding symbol for the device in question.

The controller assigns all newly paired devices to ventilation zone 1 by default. This can be changed later and different ventilation profiles can be assigned to the ventilation zones (📖 4: Operation and setup via app).

If the user disconnects a device and thus removes it from the ventilation system, the device-specific data is deleted from the internal database and an updated list is sent to all devices in the ventilation zone.

If a device is paired with the controller but is in error mode, the controller updates the device status to mark that device as offline or not present. The user is notified via the display screen or app and can correct the error.

2.2 Connect inner cover

The Connect inner cover (in the following text "inner cover") is a network inner cover (radio or RS485 data cable) and replaces the standard inner covers of the iV-Smart+, iV14-Zero, iV-Light and iV-Compact ventilation units to facilitate integration into the inVENTer Connect network. In addition to the radio interface, the inner covers have local control electronics, a power supply unit and an automatic closing flap.

It controls the speed and direction of each decentralised inVENTer ventilation unit with heat recovery connected to it.



Paired (by radio or by cable) with the controller, it is controlled by the latter.

For initial setup and to integrate the inner cover into the ventilation system (3.2, 3.3), a button and associated LED are used which provide feedback or can display the device status.

Function

If an inner cover is paired to the controller, it controls the associated ventilation unit (one ventilation unit per inner cover) using the information received from the controller. It controls 4 ventilation modes with different speed levels in which the respective inVENTer ventilation unit then operates:

- **Heat recovery**

In heat recovery mode, each ventilation unit changes direction (supply air / extract air) every 70 seconds. Ventilation units can be "paired" so that two units form a pair that works in opposite phases, i.e. one ventilation unit works in ventilation while the other one vents. After 70 seconds, both units switch over to the other direction.

- **Unidirectional ventilation**

In this ventilation mode, the units in a ventilation zone operate with a constant air flow direction, with one unit per pair of units operating in the supply air direction and the other in the extract air direction.

- **Pause function**

The ventilation units pause for a pre-defined period of time. The automatic closing flap is closed for this time. Operation is then continued on the basis of the ventilation profile selected for this ventilation zone (saved in the controller, ventilation profile tables Annex).

- **Switch off**

The ventilation units are switched off and the closing flaps close.

There are four levels for the ventilation units, which define the units' speed and air flow. These can be adapted by users to their personal values.

The factory standard settings for the ventilation levels are:

- Level 1 – 25 %
- Level 2 – 35 %
- Level 3 – 50 %
- Level 4 – 100 %

2.3 Sensor technology

Different sensors are available in the inVENTer Connect controller platform. These are required to monitor the relevant parameters in the various ventilation zones and to ensure automated ventilation control according to the set profiles. Demand-controlled ventilation is enabled in the ventilation zone assigned to the sensor on the basis of the respective reference variable. The CO₂ sensor also has a humidity/temperature sensor.

For initial setup and to integrate the sensor system into the ventilation system (📖 3.2; 📖 3.3), a button and an associated LED are used in each case.

The data transmission between the sensors and controller takes place at fixed intervals. Depending on the sensor, the value determination is defined as a fixed cycle or as a check cycle:

- Fixed cycle (60 minutes):
Here the sensor system sends a signal to the controller together with the sensor value (temperature, humidity, CO₂ content), thereby reporting its status.
- Check cycle:
Here the sensor values are read periodically and checked whether they correspond to the specified value or are within the tolerance range for this value.
If there are any deviations, the newly measured data is transmitted to the controller.

CS2-Connect CO₂ sensor (incl. humidity/temperature sensor)

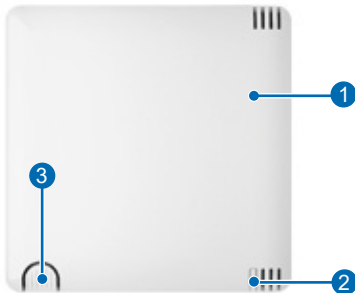

- 1 Housing with sensor electronics
- 2 LED (multi-coloured)
- 3 Button

Figure 1: CS2-Connect CO₂ sensor

The CO₂ content is a good indicator of the air quality in the room. The higher the CO₂ content of the air, the worse the air quality.

The CO₂ sensor is used for background monitoring of the CO₂ concentration in the indoor air in the ventilation zone in question. It also has a humidity/temperature sensor for monitoring the humidity indoors as well as the indoor temperature.

The CO₂ sensor operates according to the NDIR (non-dispersive, infrared) measuring principle by using an infrared light tuned to the wavelength of CO₂. The attenuation of the infra-red light is detected by the sensor and converted into a processable output signal. It detects the CO₂ concentration in the ambient air within a range of 400 – 10,000 ppm.

It transmits the CO₂ values determined to the controller by radio (RF868MHz network) or RS485 data cable. If the measured CO₂ content of the indoor air exceeds the limit defined via the app (factory setting 1,500 ppm), all ventilation units assigned to the ventilation zone are switched to ventilation operating mode, level 3.

FTS19-Connect Indoor humidity/temperature sensor



Figure 3: FTS19-Connect Indoor humidity/temperature sensor

Humidity and temperature influence the quality of the indoor air. The Indoor humidity/temperature sensor measures the relative humidity and the temperature in the indoor air, transmits the measured values to the controller by radio (RF868MHz network) and is therefore very important for a comfortable indoor climate. At an optimum humidity level, exposure to bacteria, fungi, germs and viruses is at its lowest.

The electrical measuring transducer measures humidity and temperature via a capacitive sensor and converts the measured value into a processable output signal.

The Indoor humidity/temperature sensor measures the relative humidity in the range of 20 – 90 % and the temperature in the range of 0 – 60 °C. If the measured values exceed the limit values stored in the ventilation profile (factory setting 70 %), all ventilation units assigned to the ventilation zone are switched to ventilation mode level 3.

FTS19-Connect Outdoor humidity/temperature sensor

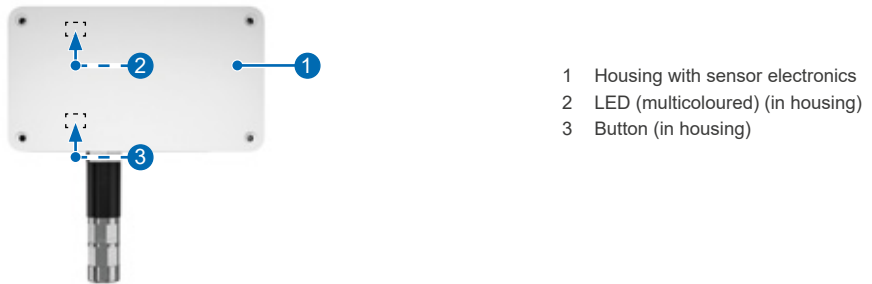



Figure 2: FTS19-Connect Outdoor humidity/temperature sensor

The Outdoor humidity/temperature sensor is a radio sensor for measuring the relative humidity and temperature in the ambient air and sending the measured values to the controller. It serves as an outdoor sensor for all ventilation zones.

The measured variables (humidity and temperature) transmitted by the sensor are mandatory for the use of the automatic ventilation profiles (automatic ventilation profiles  Annex).

The electrical measuring transducer measures the humidity and temperature via a capacitive sensor and converts the value into a processable output signal.

The Outdoor humidity/temperature sensor measures the relative air humidity in the range 20 – 90% and the temperature in the range -20 – 60 °C.

SK19-Connect switching contact

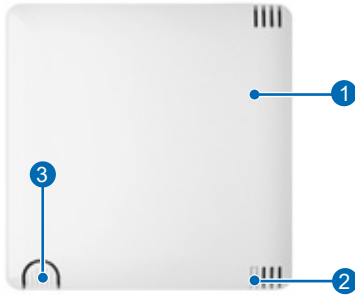

- 1 Housing with sensor electronics
- 2 LED (multi-coloured)
- 3 Button

Figure 4: SK19-Connect switching contact

The switching contact is a radio interface and is used to integrate safety devices, e.g. a 4 Pa pressure sensor, into the ventilation system while simultaneously operating the ventilation system with fireplaces.



WARNING: For joint operation with fireplaces, safety measures must be taken to prevent a negative pressure from developing in the building. The responsible chimney sweep and/or building planner decides which measures need to be carried out.

If this interface is used in conjunction with an external pressure sensor (4 Pa pressure sensor), the air pressure indoors is continuously monitored. As soon as this exceeds the safety-relevant limit value, the sensor transmits this to the controller.

The system reacts as follows:

- The controller switches off all ventilation units paired with it. The LED on the Easy Connect e16 controller flashes alternately RED and WHITE.
- The closing flaps on the Connect inner covers remain open or are opened. The LED on all Connect inner covers flashes alternately RED and GREEN.
- The LED on the SK19-Connect switching contact flashes alternately RED and GREEN.

The function remains active until the air pressure drops below the safety-relevant limit again. Then all of the ventilation units connected to the controller switch back to their originally set operating mode.

If the connection between the switching contact and the controller is interrupted, the system reacts in the same way as when the safety-relevant limit of the air pressure is exceeded.

Sensor hierarchy



TIP: Several sensors that perform the same task in a zone can be paired with the controller. The controller then arranges these according to the following sensor hierarchy:

| Sensor hierarchy | Sensor type | Component example |
|------------------|--------------------------------|------------------------|
| Priority 1 | Sensor - mains connection | CS2-Connect CO2 sensor |
| Priority 2 | Sensor - battery-operated | FTS19-Connect Indoor |
| Priority 3 | Sensor - controller-integrated | Easy Connect e16 |

Table 1: Sensor hierarchy

2.4 "inVENTer Mobile" app

The "inVENTer Mobile" app (in the following text "app") is the free app from inVENTer for Android and iOS operating systems for controlling and programming the system. For a more in-depth setup and full functionality access, a mobile device with the "inVENTer Mobile" app installed is required.

The app can be found on:



The app is used to start up the ventilation system and access the full system control functions. The app has the following menu structure after a connection is made with the controller:

- **Ventilation zone summary**

To view the status of each zone and make quick settings (such as changing the ventilation profile, ventilation mode, ventilation level, activating the boost function, etc.).

- **Device overview**

The list of devices paired in the system is displayed, including their names, ventilation zone and status information.

- **Advanced settings**

To make system settings such as adjusting the stored ventilation profiles, defining maintenance intervals and system updates.

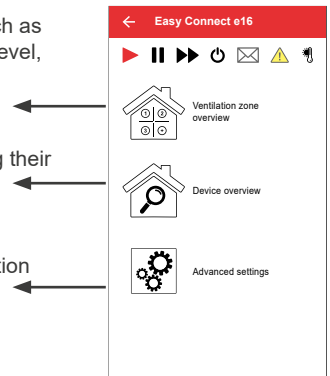

Figure 5: App menu structure

For a detailed description of the control of the ventilation system via the app, see [4: Operation and set-up with the app](#).

3 Operation and set-up on the controller

3.1 General information

Easy Connect e16 controller

The ventilation system's central control unit is the Easy Connect e16 controller. It can be operated directly or via the app.

The controller's user interface consists of 5 capacitive sensor keys. These are located on the front of the programming unit. Operation is performed in conjunction with the displays on the display screen (Liquid Crystal Display) by touching the various sensor keys.

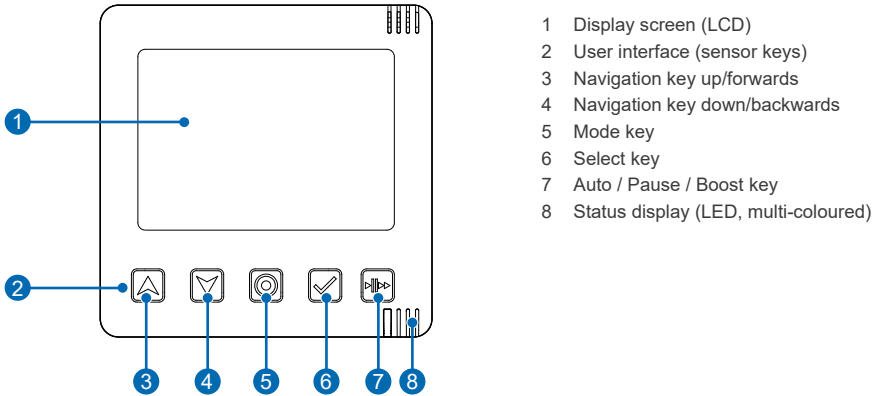

Figure 6: Front view of the controller programming unit

The sensor keys

The capacitive sensor keys available on the programming unit can be used to make quick settings for the ventilation system.



- **Navigation keys**

Use these keys to navigate and change values. These keys are also used to set the time.



- **Mode key**

This key is used to switch between different user-specific settings or to complete settings that have been made.



- **Select key**

This confirms the settings that have been made.



- **Auto / Boost / Pause key**

This key is used to set the ventilation modes Auto/Pause/Boost globally or for each zone.

The mode key – brief overview

The mode key can be used to trigger system configurations. The different actions are triggered by holding the mode key for different lengths of time.

- **Activate controller/call up zone selection menu:**

Press the mode key briefly and release it again.

The menu for selecting a ventilation zone opens. You can then use the navigation keys to select a ventilation zone and call up its status (select key).

During this time the LED lights up solid WHITE.

- **Activating pairing of system components:**

3 seconds



hold down

Press the mode key and hold it down for 3 seconds.

This activates system component pairing for a predefined time to establish a connection with the ventilation units and sensors. During this time the LED flashes WHITE.

- **Activating the Bluetooth connection:**

6 seconds



hold down

Press the mode key and hold it down for 6 seconds.

This activates Bluetooth pairing for a predefined time to establish a connection with the mobile application (app). During this time the LED flashes BLUE.

- **Performing a reset:**

10 seconds



hold down

Press the mode key and hold it down for 10 seconds.

Then confirm the reset procedure by briefly pressing the key again. This will delete all paired devices and reset all settings. If the operation is not confirmed, the controller automatically returns to the normal ventilation operation specified by the ventilation profile without resetting.

"Pressing and holding" the mode key is cyclical. If the mode key is pressed for longer than 15 seconds, the activation of the pairing of system components becomes active again.

The status LED (RGB LED)

The status LED indicates the status of the controller using different colours.

The following displays are possible:

| LED colour | LED state | Status of the controller |
|-------------|--------------------|---|
| WHITE | Solid | Controller in normal ventilation mode |
| WHITE | Flashing | Controller is ready for pairing with new components (inner covers, sensors) |
| BLUE | Flashing | Bluetooth connection is being established |
| BLUE | Solid | Bluetooth connection established |
| RED / WHITE | Alternate flashing | Error is displayed |
| YELLOW | Flashing | An update is being transferred to the controller |

Table 2: Status LED display

The display screen

The display screen shows all information about the ventilation system.

There are the "System information" and "Settings menus" display menus.

By default, the display screen shows the system information for ventilation zone 1. After 30 seconds without input, the backlight switches off. If the system information for another ventilation zone, e.g. ventilation zone 3, is displayed, the Easy Connect e16 controller switches back after 3 minutes without input and the current parameters of ventilation zone 1 are displayed again (idle state).

To activate the display screen from idle mode, press any sensor key. The backlight is switched on and you can make settings or view the values of other ventilation zones transmitted to the controller.

"System Information" display menu

No settings can be made in the display menus; they serve as an overview of the parameters currently set for a ventilation zone (e.g. ventilation profile) and/or transmitted by sensors. They are the starting point for making settings.

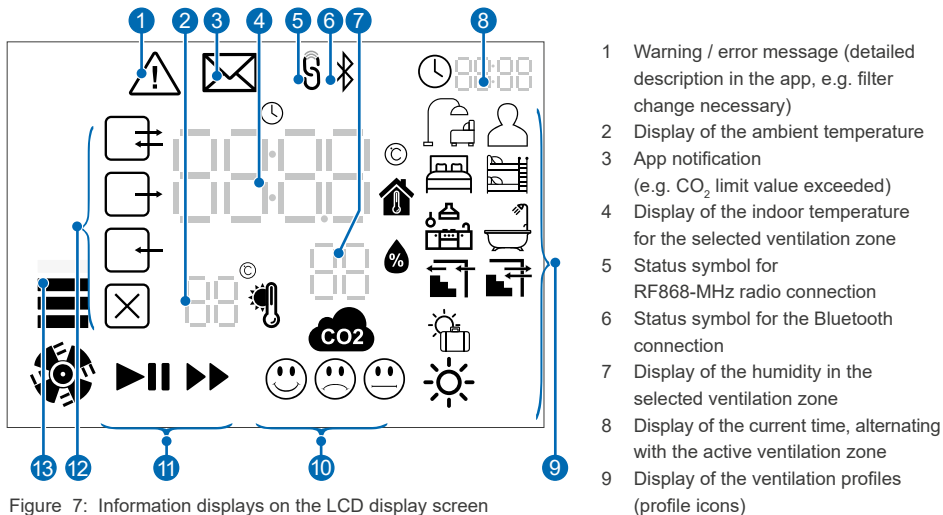



Figure 7: Information displays on the LCD display screen

Inner cover, sensor technology, switching contact

The inner cover, sensor technology and switching contact only need to be operated during initial setup or after restarting the ventilation system. If they are paired with the controller and thus integrated into the ventilation system, they communicate and/or supply the measured values automatically. No further operation on the devices is required; settings are made via the controller.

During initial commissioning, a button on the device is used for operation. A multi-coloured status LED (position see  2.2: Inner cover and 2.3: Sensor system) shows the status of the respective device by lighting up in different colours.

The following displays are possible and uniform for all devices to be paired:

| LED colour | LED state | Status of the controller |
|------------|-----------|--------------------------|
| TURQUOISE | Solid | Device not paired |
| GREEN | Flashing | Devices are paired |
| GREEN | Solid | Device pairing completed |

Table 3: Status LED display of paired devices

3.2 Initial setup of the controller

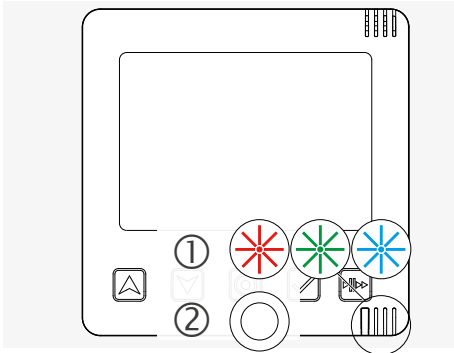

Requirements:

- The controller and all devices relevant to the ventilation system are installed.
- ▶ Establish the power supply for all devices in the system.
- ⇒ The controller performs firmware and hardware checks for the system. The LED flashes RED, GREEN and BLUE during this process (1).
- ⇒ After a successful firmware and hardware check, the LED lights up WHITE (2).
- ⇒ The controller changes to the radio channel setting.

Selecting the channel for the RF868-MHZ radio connection

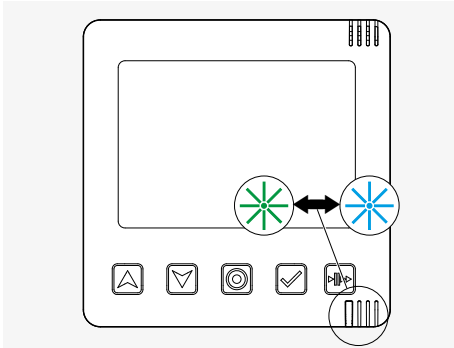

Requirements:

- Firmware and hardware check successful.
- ⇒ The controller searches for the best radio channel, the LED flashes alternately GREEN and TURQUOISE.



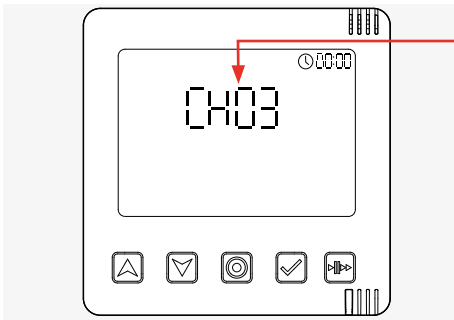

TIP:

There are 5 channels available. We recommend using the automatically assigned channel. Different channels can be selected for adjacent residential units.



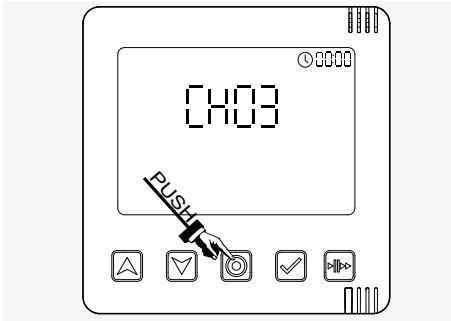

- ⇒ The best radio channel is indicated on the controller's display. The LED flashes alternately GREEN and TURQUOISE.

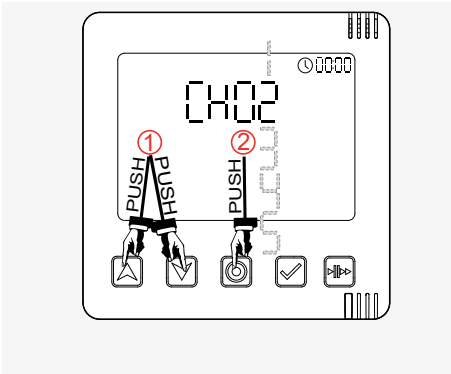

- ▶  Press the mode key to confirm the best channel.



- OR:
Manually select another channel:
- ▶  Press the navigation keys (up and down arrow key) to navigate through the available channels (1).
 - ▶ 
 - ▶  Press the mode key to confirm the selection (2).

⇒ The controller changes to the time and date setting.

Time and date setting

The time and date are set only when the system is set up with the controller. If set-up is carried out via the app, the time and date are automatically taken from the app. Manual setting of the date and time is then dispensed with.



TIP: This setting can be skipped by pressing the mode key.

Setting the time

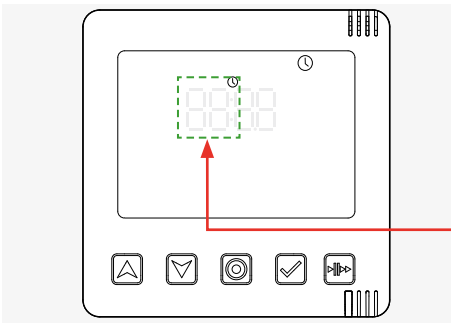



Requirements:

- Setup by means of the controller.
- Firmware and hardware check successful.
- The channel for the RF868-MHZ radio connection is selected.

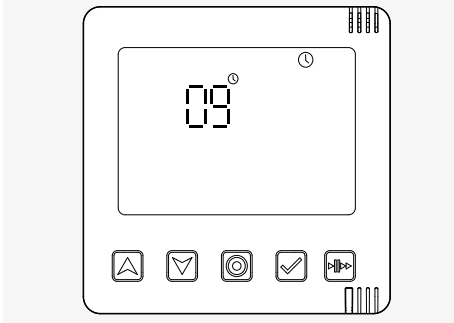
⇒ The hour setting is active and flashing.



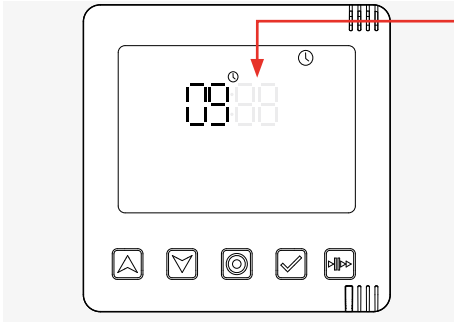

- ▶  Set the hours by pressing the navigation keys (up and down arrow key).
- ▶   Press the select key to confirm the selection (hours).

⇒ The hours are set.



⇒ The next field for setting (minute display) becomes active and flashes.

- ▶   Press the navigation keys (up and down arrow key) and set the minutes.

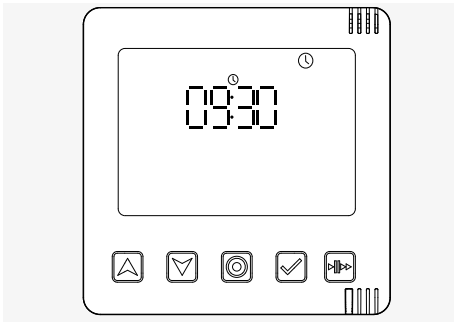

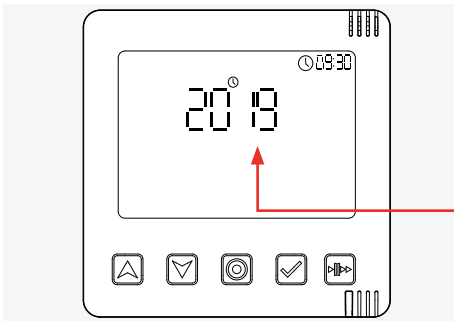

- ▶  Press the mode key to complete the time setting and go to the date setting.

Setting the date

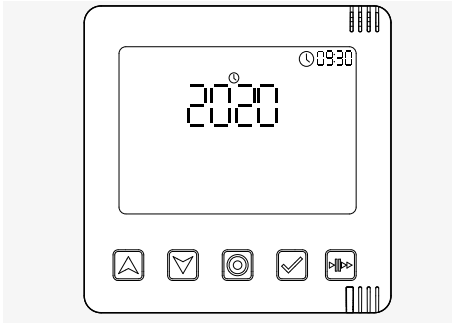

⇒ The year display is active and flashes.





- ▶  Press the navigation keys (up and down arrow key) until the required year is set.
- 

- ▶  Press the mode key until the day setting in the date setting menu flashes, making it active.

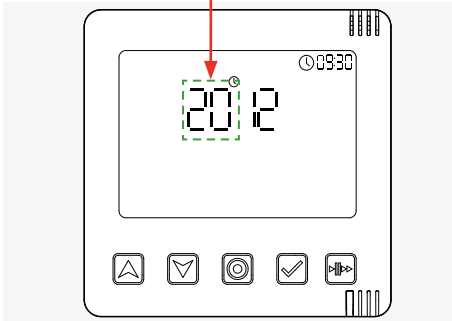
⇒ The day display is active and flashes.





- ▶  Press the navigation keys (up and down arrow key) until the required day is set.
- 

- ▶  Press the select key to confirm the selection (day).

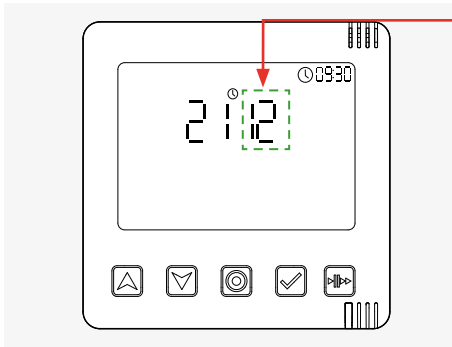
⇒ The day is set and the next field for setting (month display) becomes active and flashes.



- ▶  Press the navigation keys (up and down arrow key) until the current month is set.
- 

⇒ The current month is set.

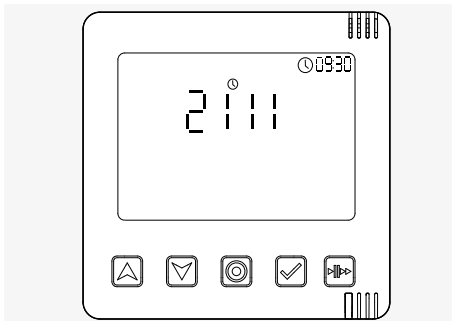

- ▶  Press the mode key and confirm the set day and month.

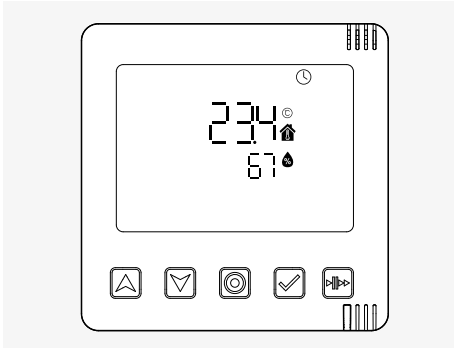

⇒ The display screen shows the determined values for room temperature and humidity at the controller's installation location.

Up to 16 system components (ventilation devices [Connect inner covers], sensors, switching contact) can be paired with the Easy Connect e16 controller.

The controller system can then be set up via the "inVENTer Mobile" app or on the controller, e.g. setting ventilation profiles. We recommend setting it up via the app.

To download the app:



3.3 Pairing of system components

To pair system components with the Easy Connect e16 controller and thus integrate them into the inVENTer Connect controller platform, component pairing must first be activated on the controller. Then all system components to be integrated must be activated so that they can be recognised and paired by the controller.

Activate component pairing on the Easy Connect e16 controller. To do this:

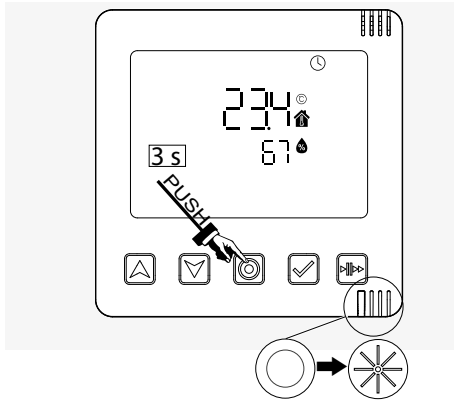

- ▶  Press and hold the mode key for 3 seconds.

⇒ The LED lights up WHITE. After the mode key is released, the LED flashes WHITE.

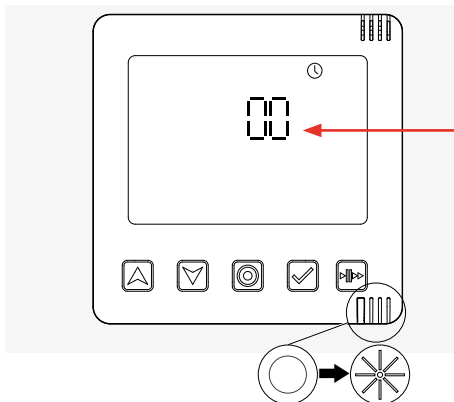

⇒ "00" appears on the display screen as long as no component (inner cover, sensor or switching contact) has been detected and paired.

While the white LED is flashing (approx. 5 minutes), the first device to be integrated must be activated so that it can be recognised and paired by the controller.



TIP:

Activated units are automatically recognised and paired by the controller.

Pairing the Connect inner cover

Before pairing the ventilation units (via the Connect inner cover), remove the Connect inner cover's closing flap.

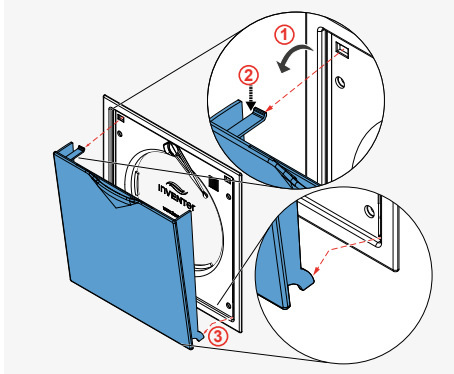

- ▶ Pull the closing flap forward, away from the electronics cover (1).
 - ▶ Press the spring clip at the top slightly downwards (2) so that it slides out of the opening provided when the electronics cover is pulled forwards.
 - ▶ Lift the lower lugs out of the guide and remove the closing flap (3).
- ⇒ The electronics cover becomes visible and accessible.



Tool (pin Ø 2 mm / 50 mm long), e.g. screwdriver

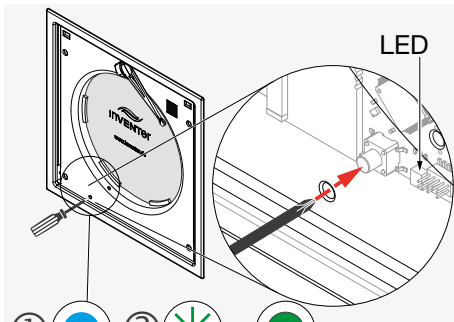

Requirements:

- The Connect inner cover is connected to the power supply.

- ▶ Push a tool (e.g. a small screwdriver) through the hole as shown to operate the button behind it.
- ▶ Press the button to activate the Connect inner cover.

⇒ The LED lights up TURQUOISE (1).

- ▶ Press and hold the button again until the LED lights up GREEN (approx. 3 s).

⇒ The Connect inner cover is ready for pairing with the controller. The LED on the Connect inner cover flashes GREEN during component pairing and lights up solid GREEN when pairing has been completed.



⇒ On the controller's display screen, after successful pairing, the displayed number increases by the paired component to "01".

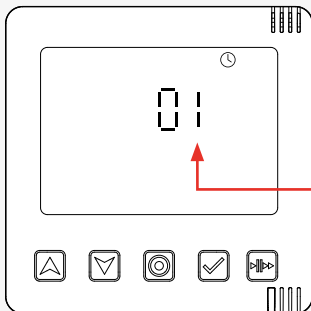

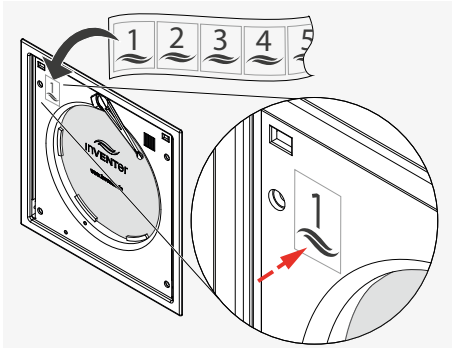

- ▶ Mark the first paired component (in this case the Connect inner cover) with the supplied number sticker. Number 1 for the first paired device.



TIP:

For a better overview, management and later assignment to ventilation zones, it is useful to identify the sequence of the paired components with the supplied numbers.

- ▶ Continue with the activation of further Connect inner covers and their pairing.

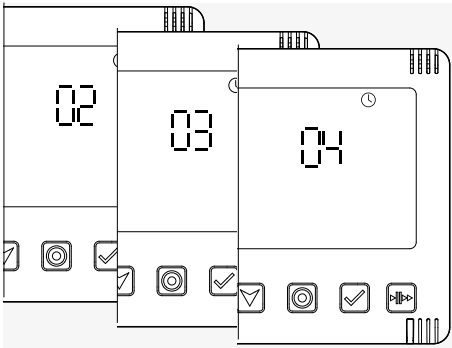

- ⇒ On the controller's display screen, the number shown increases with each paired Connect inner cover.



- ▶ Mark the paired Connect inner covers consecutively.

After pairing all Connect inner covers, the closing flaps must be refitted. If other components (sensors, switching contact) are paired to the controller, this step can also be performed at the end of the pairing process.

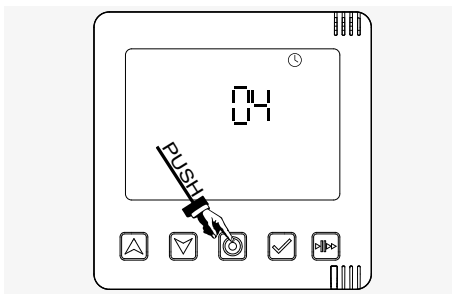

- ▶ Press the mode key to confirm the paired components.

- ⇒ The display screen shows the information that the paired Connect inner covers send to the controller.

Attaching closing flaps / swivelling the locking arm to the right



NOTICE: Locking arm in wrong position. Breakage of the locking arm.

Before the closing flap is refitted, the locking arm must be swivelled to the right. This is done exclusively by the controller. To do this, **switch all devices to pause**



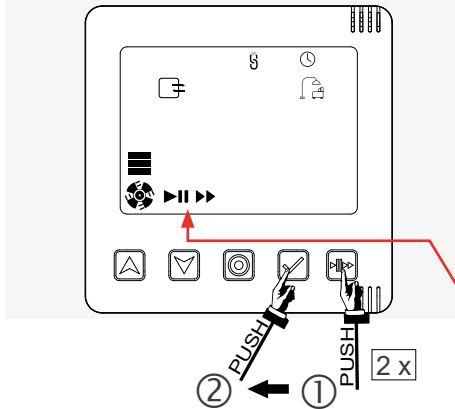

(📖 3.6: Boost/Pause or when operating via app 📖 4.8: Set ventilation mode and level).

Never swivel the locking arm by hand!



Requirements:

- The Connect inner covers (and any other components) are paired with the controller.
- The "System Information" display screen is called up.

- ▶  Press the Boost/Pause key (1) on the controller.
- ⇒ The first symbol flashes.
- ▶  Press the Boost / Pause key on the controller again until the Pause symbol  flashes.
- ▶  Press the selection key on the controller to confirm the pause (2).

⇒ The locking arm swivels to the right.

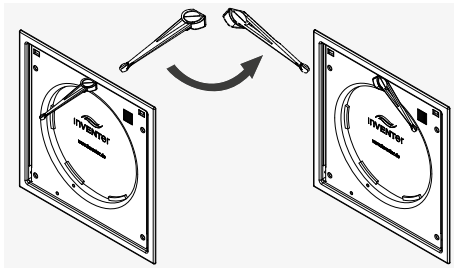

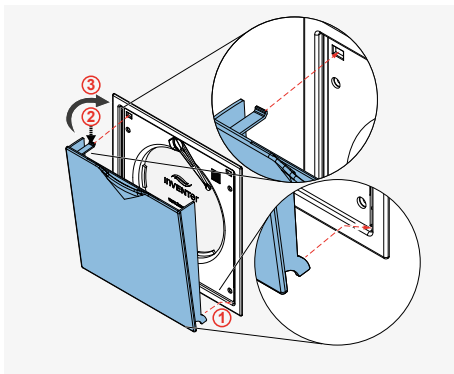

Fit the closing flap.

- ▶ Hook the lugs of the closing flap into the electronics cover at the bottom (1).
- ▶ Press the spring clip at the top slightly downwards (2).



- ▶ Guide the closing flap to the top of the electronics cover (3), pushing the spring clip, which is slightly pressed down, into the opening provided in the electronics cover.

The spring clip engages and the closing flap is pulled and held by the installed magnets to the electronics cover.

- ▶ Exit the pause function:
Press the Boost / Pause button on the controller several times again until the  symbol flashes. Confirm with the select key .

⇒ You have refitted the closing flap.

Pairing sensors

Requirements:

- The CS2-Connect CO₂ sensor and the SK19-Connect switching contact are connected to the power supply, the FTS19-Connect Indoor/Outdoor humidity/temperature sensors are equipped with batteries (2xAAA each).
- The mode key on the controller was pressed, held down for 3 seconds and the LED is flashing WHITE.

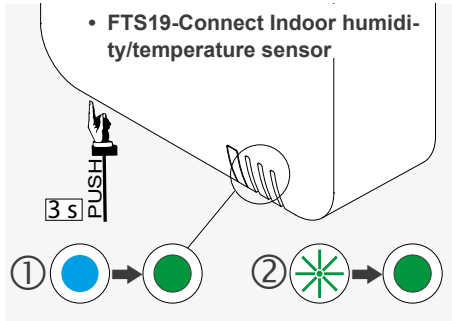

- ▶ Press the corresponding button to activate the sensor.
(FTS19-Connect Inside: on the underside of the housing).

⇒ The LED lights up TURQUOISE (1).

- ▶ Press and hold the button again until the LED lights up permanently GREEN (approx. 3 s).

⇒ The sensor is ready, is automatically recognised and paired by the controller (LED flashing green, 2).

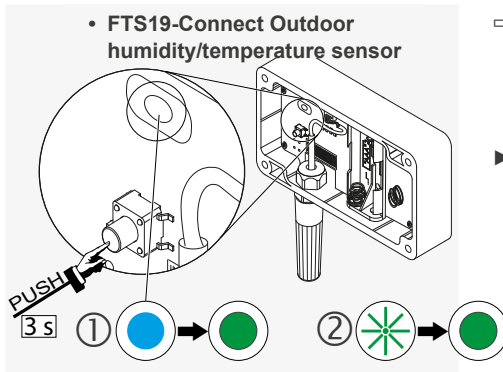

⇒ On the controller's display screen, after successful pairing, the displayed number of paired components increases. The LED on the sensor lights up permanently GREEN. (2)

- ▶ Continue numbering the paired components.

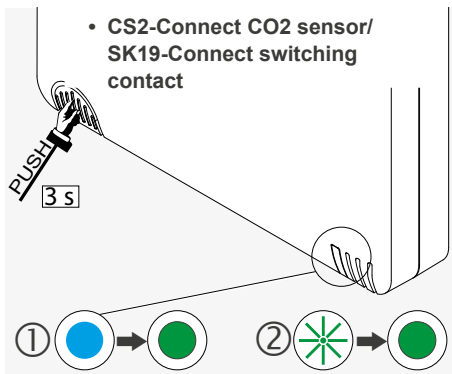

Ending device pairing

The system exits the device pairing state when:

- the maximum number of paired devices is reached (max. 16),
- the time is exceeded,
- or a corresponding key entry is made.

Termination by key entry

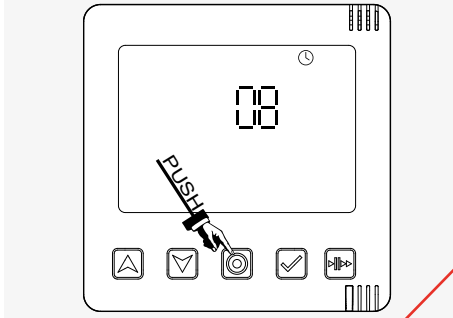

Requirements:

- All components relevant to the ventilation system are paired.
- The display screen shows the number of paired components.

- ▶  Press the mode key to confirm the paired components.

⇒ The display screen shows the information that the paired system components (inner covers, external sensors, switching contact) send to the controller.

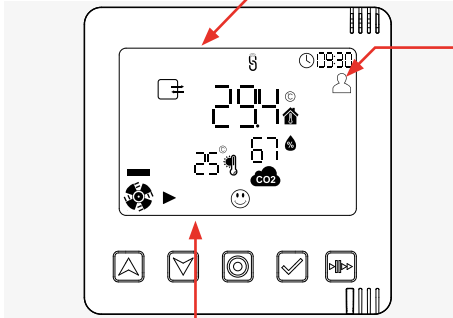

⇒ The system operates in the default profile (factory settings).

If not already done, the closing flap must be reattached to the inner cover at this point. See Page 26; Swivelling the locking arm to the right.

Start screen: System information

After all inner covers (ventilation units) and sensors have been paired with the controller and the pairing of the components has been confirmed, the ventilation systems starts with the factory settings, i.e.:

- all ventilation units and sensors are assigned to ventilation zone 1.
- the predefined ventilation profile for ventilation zone 1 is set (default profile).

In the factory-set default profile, the system operates at 25 % fan speed and in heat recovery mode.

It is possible to define up to four ventilation zones. Different ventilation units, sensors and profiles can be assigned to the individual ventilation zones.

Please note: additional ventilation zones can only be set up via the app ( 4: Operation and set-up with the app).

3.4 Selecting ventilation zones / Showing the status of ventilation zones

The status of the ventilation zones is displayed directly by the controller (description below) or can be viewed using the app (📖 4: Operation and set-up with the app).

After component pairing, all paired components are assigned to ventilation zone 1. The controller automatically starts with the factory settings (default profile) and displays the status of ventilation zone 1.

Additional ventilation zones can only be set up via the "inVENTer-Mobile" app.

If additional ventilation zones (max. 4) have been set up (📖 4: Operation and set-up with the app) and each newly set up ventilation zone is assigned a corresponding profile, the status information can also be displayed on the display screen.

After a defined period (approx. 3 minutes), the controller switches the view so that the status of ventilation zone 1 is displayed again.

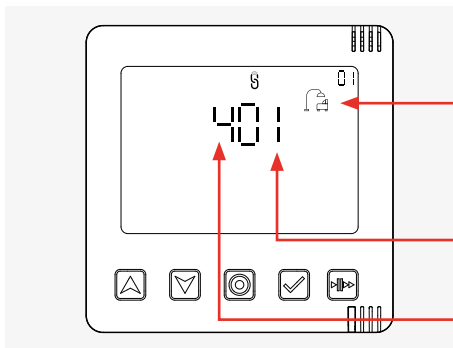

Requirements:

- Up to a maximum of 4 zones are set up using the app.

- ▶  Press the mode key. The first defined ventilation zone (ventilation zone 1) appears with its profile icon.
- ⇒ Ventilation zone 1 and the corresponding profile icon are displayed.
- ⇒ The display screen shows the total number of possible ventilation zones.

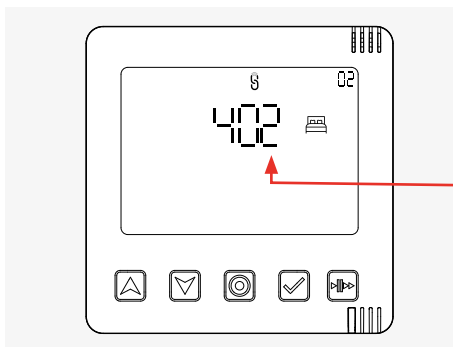

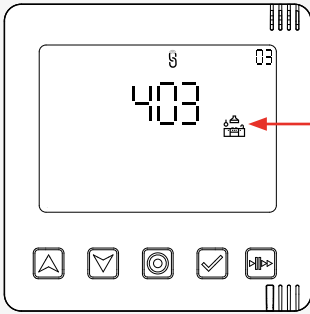

- ▶  Use the up arrow key to navigate through the ventilation zones until the desired ventilation zone appears on the display screen.
- ⇒ The next ventilation zone (ventilation zone 2) and the corresponding profile icon are displayed.

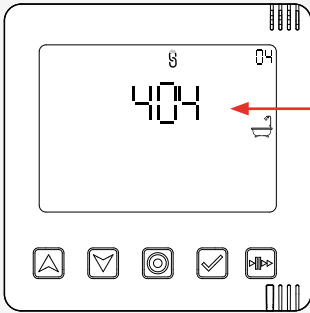

▶  Use the up arrow key to navigate further until the next ventilation zone appears on the display screen.

⇒ The next ventilation zone (ventilation zone 3) and the corresponding profile icon are displayed.



▶  Use the up arrow key to navigate further until the next ventilation zone appears on the display screen.

⇒ The next ventilation zone (ventilation zone 4) and the corresponding profile icon are displayed.

Once the desired ventilation zone is reached:

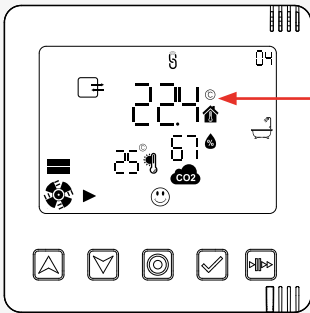

▶  Press the select key to confirm the selected ventilation zone (here, ventilation zone 4).

⇒ The status incl. all relevant measured values of the selected ventilation zone is displayed.

⇒ The displayed number of the ventilation zone changes with the time display at the top left-hand edge of the screen.

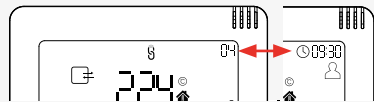



3.5 Changing the fan settings

For each ventilation zone (max. 4), time-limited settings for ventilation level and ventilation mode can be made on the Easy Connect e16 controller. Ventilation profiles can also be assigned to the individual zones. These are then permanently assigned.

To do this, select the ventilation zone for which the settings are to be changed as described in chapter 3.4.

If no ventilation zones are set up in the system, the settings you have made will be applied globally to all ventilation devices in the system.

Changing the fan settings – brief overview

- Switching between the setting options is done by pressing the select key .
- The values can then be changed using the arrow keys. When setting, the active symbol flashes in each case.
- Press the mode key  to exit the settings menu and return to the display menu. The last setting selected (last flashing symbol) is set as active.

The selection order is as follows:

Ventilation level



Ventilation mode



Ventilation profile

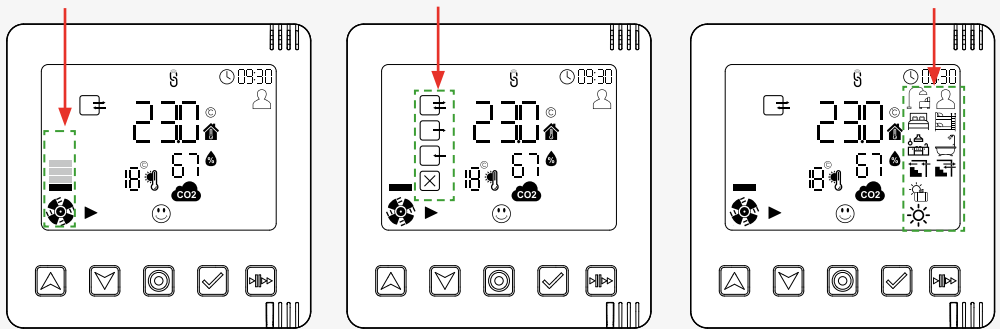

Setting the ventilation level (time-limited change)

You can set the air flow using the controller to up to 4 levels. The default values for each of these levels are:

- Level 1 – 25 %
- Level 2 – 35 %
- Level 3 – 50 %
- Level 4 – 100 %

The air flow for each of these 4 levels can be changed via the app. If the default value was changed via the app, the changed air flow is also effective on the controller.

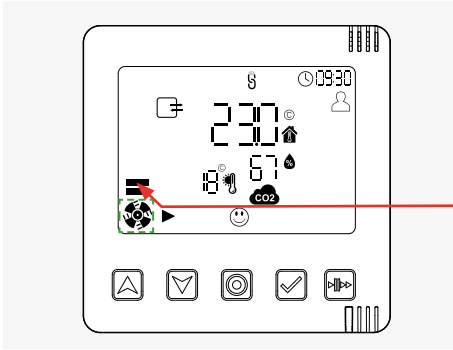

Requirements:

- The "System Information" display screen of the selected zone is called up.

▶  Press the selection key.

⇒ The symbol for the ventilation level (air flow) starts to flash.

▶  Press the arrow keys to change the ventilation level directly.



- Up arrow key:
The ventilation level is increased, the fan power increases.
- Down arrow key:
The ventilation level is reduced, the fan output decreases.

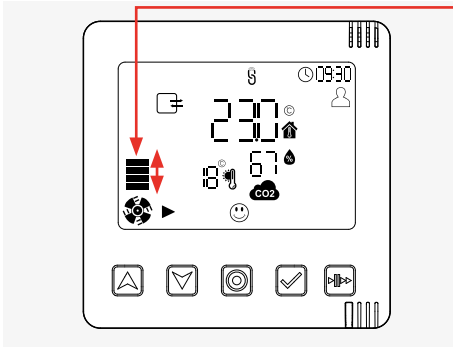

Once the desired ventilation level is reached:

▶  Press the selection key to move to the next setting option. Your change is active.

⇒ The symbol for ventilation mode (operating mode) starts to flash.

OR

▶  Press the mode key to exit the Settings menu. Your change is active.

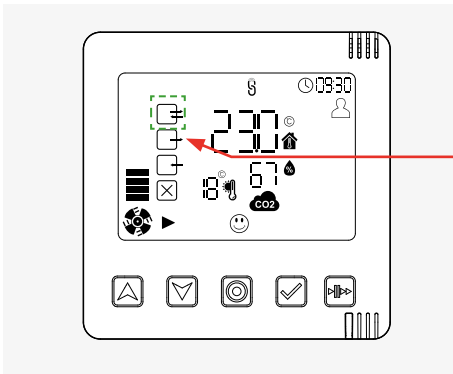

A changed ventilation level is effective for 1 hour as standard and overrides the stored ventilation profile. This duration can be changed via the app. The system then returns to the values stored in the ventilation profile.

Setting the ventilation mode (operating mode, time-limited change)

The ventilation units operate in three ventilation modes with different ventilation levels. These modes are:

| Ventilation mode | Symbol |
|----------------------------|----------------------------------|
| Heat recovery | |
| Unidirectional ventilation | (both icons always act together) |
| OFF | |

Table 4: Ventilation modes (operating modes)

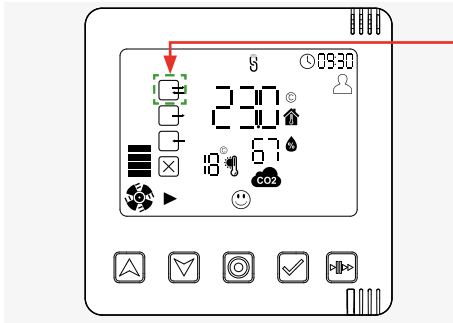

Requirements:

- The symbol for the ventilation mode set in the ventilation profile flashes (from the "System Information" screen: Press the selection key 2 times).

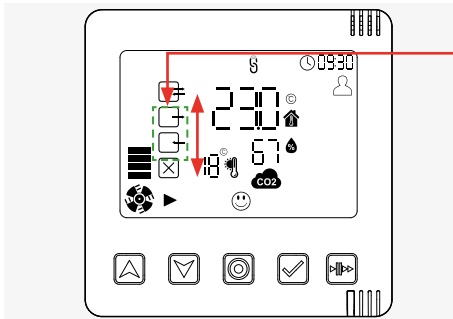

- ▶ Press the arrow keys and navigate through the ventilation modes. The respective selectable symbol flashes.
- ▶

Once the desired ventilation mode is reached:

- ▶ Press the selection key to move to the next setting option. Your change is active.

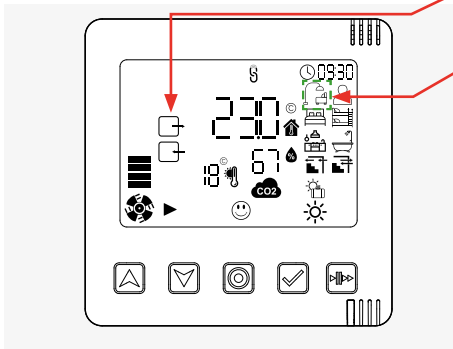

- ⇒ The icon for the selected ventilation mode appears on the display screen.
- ⇒ The next symbol (ventilation profile symbol) starts flashing.

OR

- ▶ Press the mode key to exit the Settings menu. Your change is active.

The changed ventilation mode is effective for 1 hour by default. This duration can be changed via the app. The system then returns to the values stored in the ventilation profile.

Setting the ventilation profile

Various predefined ventilation profiles are already stored in the Connect controller system. These are pre-configured for the different ventilation zones in the usage unit and, based on a time regime or sensor values, automatically control the ventilation system for each ventilation zone set up. These can be adapted to individual wishes and/or circumstances at any time.

Two different types of ventilation profile are used:

- Time-controlled profiles
- Automatic profiles (sensor-controlled)

Time-controlled profiles

Time-controlled profiles are based on a weekly timer. The ventilation level and ventilation mode thus depend on the day of the week and time of day. In this way, it is possible to set the time and day at which a change of ventilation level and/or ventilation mode is to take place to the hour. The time (7 days, 24 h each), the ventilation level (levels 1-4) and the ventilation mode (heat recovery, unidirectional ventilation or pause) are defined for the respective profile. Sensors integrated into the ventilation zone (e.g. CO₂ sensor) have priority over the values stored in the weekly timer. 7 time-controlled ventilation profiles are predefined and listed in a profile table ( Annex):

- | | | | | | |
|-------------------|---|------------|---|-------------------|--|
| • Living room |  | • Bathroom |  | • Default profile |  |
| • Bedroom |  | • Kitchen |  | • Holiday mode |  |
| • Children's room |  | | | | |

Automatic profiles

These automatic profiles are not based on schedules. With these, the comparison of internal and external temperature and humidity data is used to determine the appropriate settings for the ventilation levels and ventilation mode. Based on these parameters, the system ventilates fully automatically and independently selects the appropriate measures.

The following automatic profiles are available:

- Cellar ventilation with heat recovery
- Cellar ventilation without heat recovery
- Summer mode

The operation of the two cellar ventilation profiles is based on dew point control.

The automatic profiles can only be activated if:

- an Outdoor humidity/temperature sensor is installed,
- the selected ventilation zone has an Indoor humidity/temperature sensor or a CO₂ sensor or a direct controller.

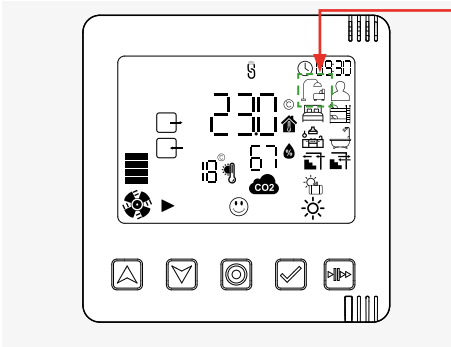

If these sensors are removed or are not paired with the controller, this ventilation zone is reset to the default ventilation profile and a notification is sent to the user.

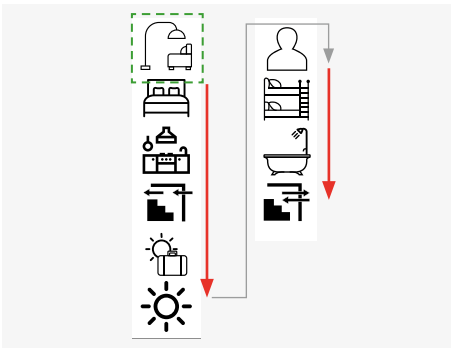

Requirements:

- The symbol for the ventilation profile is flashing (from the "System Information" screen: Press the selection key  3 times).



- ▶  Press the arrow keys and navigate through the ventilation profiles. The respective selectable symbol flashes.
- 

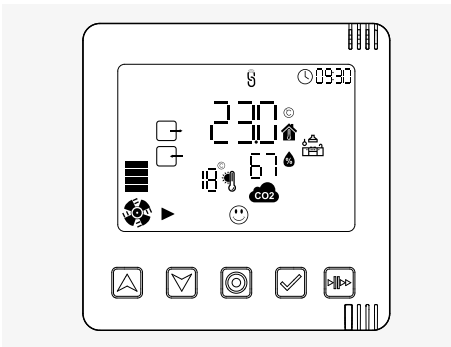

Once the desired ventilation profile has been reached:

- ▶  Press the mode key to exit the Settings menu. Your change is active.

OR

- ▶  Press the selection key to move to the next setting option (ventilation level) again. Your change is active.

⇒ The icon for the selected ventilation profile appears on the display screen.

⇒ The symbol for the first setting option (ventilation level) starts to flash.

3.6 Activating the boost / pause function globally

The boost / pause function can be activated for the entire system or specifically for each ventilation zone. This chapter describes how to activate the boost/pause function for the entire system.

The procedure for activating the boost / pause function only for a specific ventilation zone can be found in [3.7: Activating the boost / pause function by zone](#).

Activating the pause function globally

Requirements:

- The "System information" display screen of any ventilation zone, here ventilation zone 1 (standard zone), is called up.

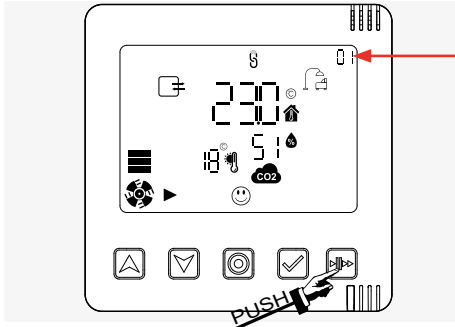

- ▶  Press the Boost/Pause key.

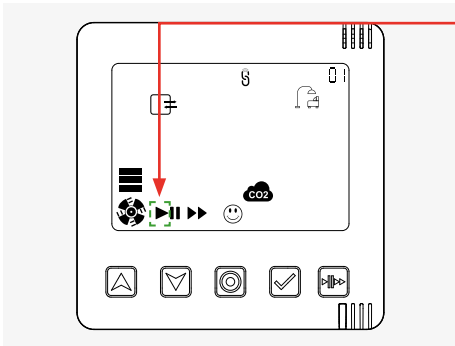

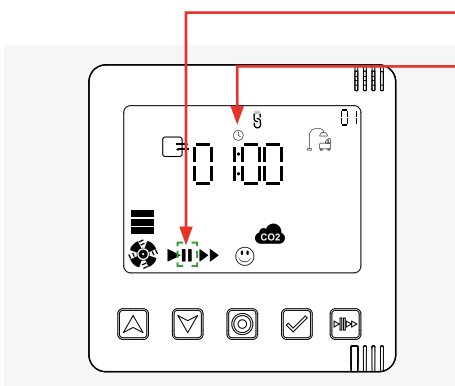

⇒ The auto symbol flashes on the display screen.

- ▶  Press the Boost/Pause key.





⇒ The pause symbol flashes on the display screen.

⇒ At the same time, the pause function time setting (timer) appears on the display screen.

- ▶   Press the up and down arrow keys to set the desired time for pause mode.

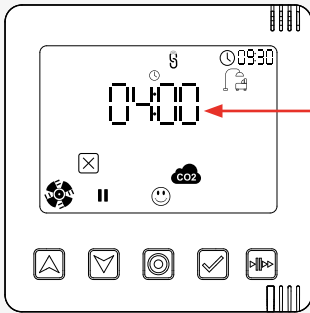
When setting the pause time, you can choose between 1, 2, 4 and 8 hours.



▶  Press the select key to confirm the selected time setting.

⇒ The desired pause time is set for all ventilation zones in the system, here e.g. 4 hours.

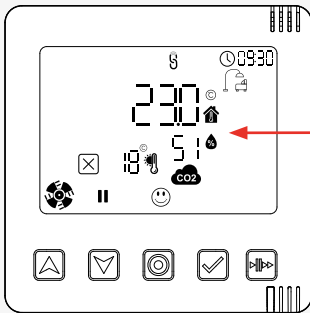

⇒ The zone status (system information) for the current ventilation zone appears on the display screen. Here it is ventilation zone 1 (standard zone).

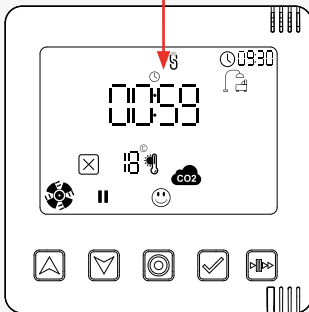

⇒ Alternating with the zone status, the remaining pause time is displayed.

The set pause time is displayed alternately with the zone status until it expires.

Activating the boost function globally



TIP: To activate boost mode, the same steps as for activating pause mode must be carried out, except that the boost / pause key must be pressed once more to activate the boost symbol.

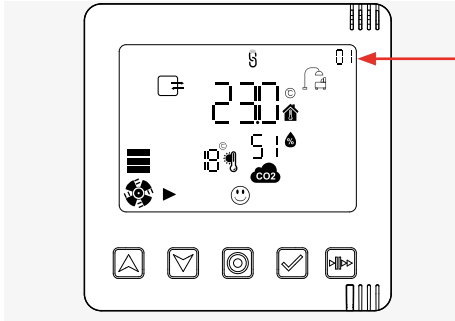

Requirements:

- The "System information" display screen of any ventilation zone, here ventilation zone 1, standard zone, is called up.

- ▶  Press the Boost/Pause key.

⇒ The auto symbol flashes on the display screen.

- ▶  Press the Boost/Pause key.

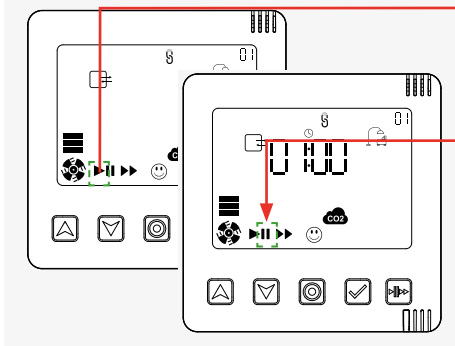

⇒ On the display screen, the pause symbol flashes and at the same time the pause function time setting (timer) appears.

- ▶  Press the Boost/Pause key again.



⇒ On the display screen, the boost symbol starts flashing:

⇒ At the same time, the boost function time setting (timer) appears.

- ▶  Press the up and down arrow keys to set the desired time for boost mode.
- ▶ 

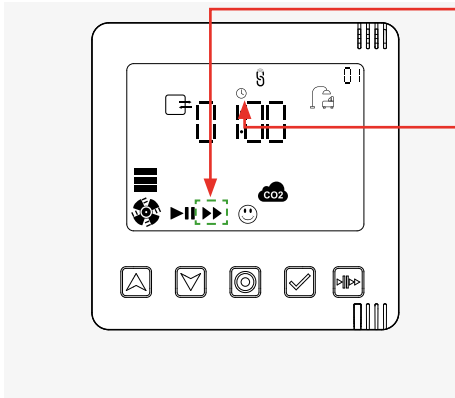

When setting the boost time, you can choose between 1, 2, 4 and 8 hours.

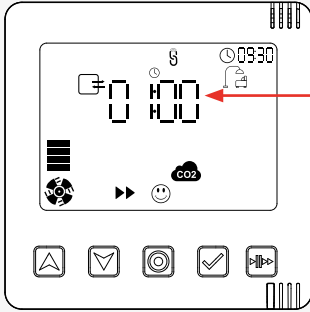

▶  Press the select key to confirm the selected time setting.

⇒ The desired boost time is set for all ventilation zones of the system, here e.g. 1 hour.

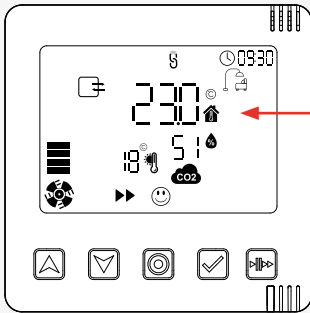

⇒ The zone status (system information) for the current ventilation zone appears on the display screen. Here it is ventilation zone 1 (standard zone).

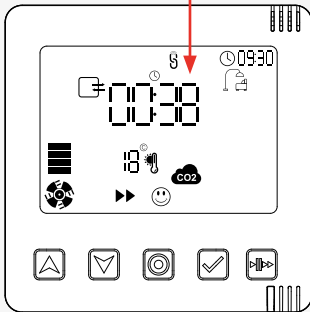

⇒ Alternating with the zone status, the remaining boost time is displayed.

The set boost time is displayed alternately with the zone status until it expires.

3.7 Activating the boost / pause function by zone

The boost / pause function can be activated for the entire system or specifically for each ventilation zone. This chapter describes how to activate the boost/pause function for a specific ventilation zone.

The procedure for activating the boost / pause function globally for the entire ventilation system is described in 3.6: Activating the boost / pause function globally.

Activating the pause function by zone

Requirements:

- The "System information" display screen of any ventilation zone, here ventilation zone 1, standard zone, is called up.

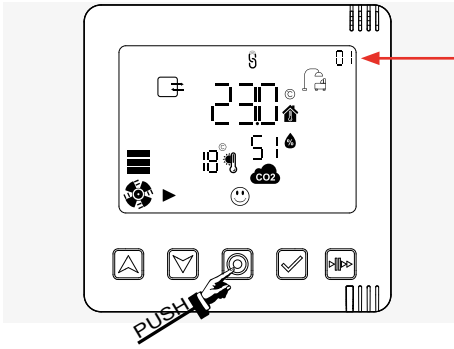

- ▶  Press the mode key until the zone selection window appears on the display screen.

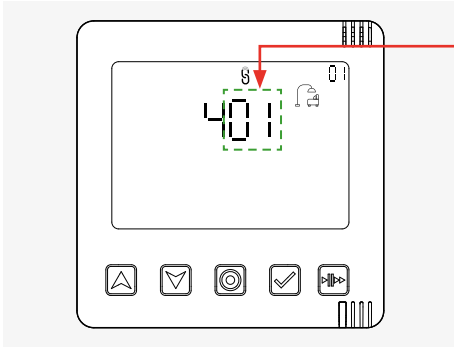

⇒ The zone selection for ventilation zone 1 is shown on the display screen.

- ▶ Select the ventilation zone for which the pause function is to be set:

- ▶  Press the up arrow key to navigate to the next zone until you reach the desired zone. Here it is ventilation zone 2, for example.

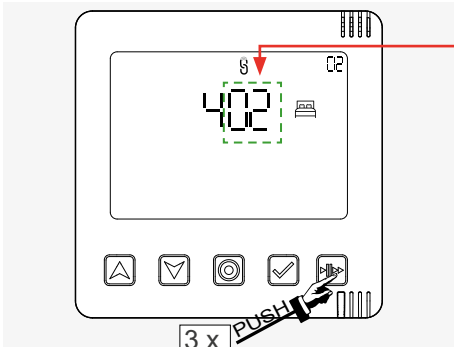

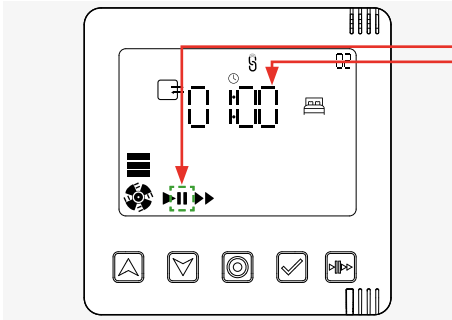

⇒ You have selected the zone for which the pause function is to be set.

- ▶  Press the Boost / Pause key 3 times in succession.



⇒ On the display screen, the pause symbol flashes and at the same time the pause function time setting (timer) appears.

- ▶  Press the up and down arrow keys to set the desired time for pause mode.
- 

When setting the pause time, you can choose between 1, 2, 4 and 8 hours.

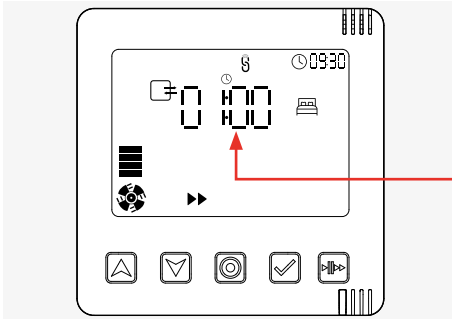

- ▶  Press the select key to confirm the selected time setting.

⇒ **The desired pause time is set for the selected ventilation zone, here e.g. 4 hours.**



⇒ The display screen shows the zone status (system information) for the ventilation zone that is in pause function, here ventilation zone 2.

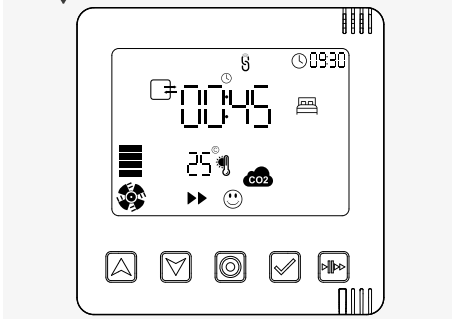

⇒ Alternating with the zone status, the remaining pause time is displayed.

The set pause time is displayed alternately with the zone status until it expires.

Activating the boost function by zone

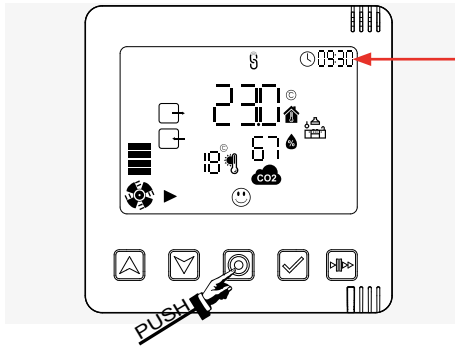

Requirements:

- The "System information" display screen of any ventilation zone, here ventilation zone 1, standard zone, is called up.

- ▶  Press the mode key until the zone selection window appears on the display screen.

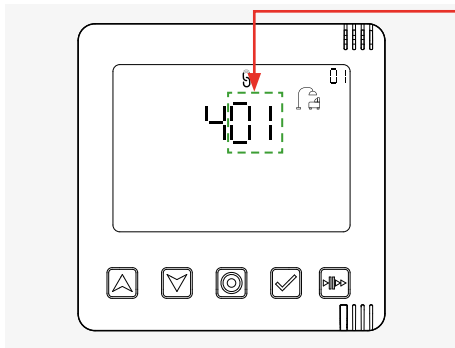

- ⇒ The zone selection for ventilation zone 1 is shown on the display screen.

- ▶ Select the ventilation zone for which the boost function is to be set:

- ▶  Press the up arrow key to navigate to the next zone until you reach the desired zone. Here it is ventilation zone 2, for example.

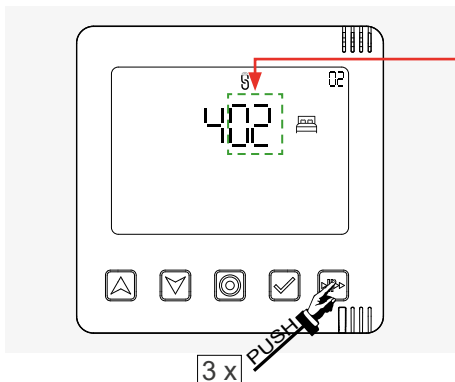

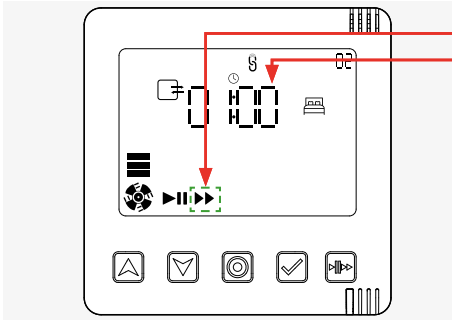

- ⇒ You have selected the zone for which the boost function is to be set.

- ▶  Press the Boost / Pause key 3 times in succession.



⇒ The boost symbol flashes on the display screen and the boost function time setting (timer) appears at the same time.

- ▶  Press the up and down arrow keys to set the desired time for boost mode.
- 

When setting the boost time, you can choose between 1, 2, 4 and 8 hours.

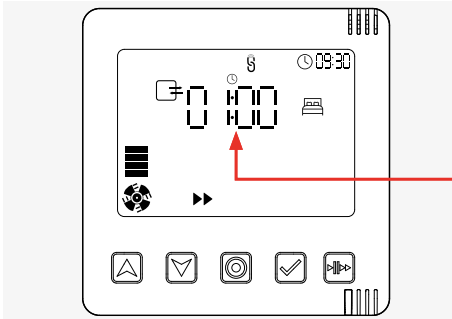

- ▶  Press the select key to confirm the selected time setting.

⇒ **The desired boost time is set for the selected ventilation zone, here e.g. 1 hour.**

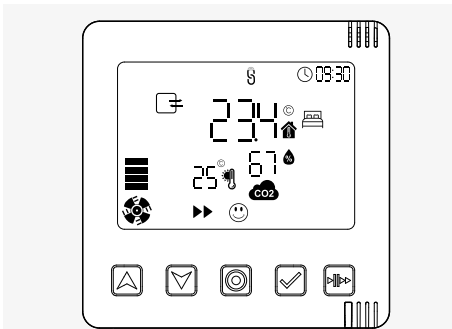

⇒ The display screen shows the zone status (system information) for the ventilation zone that is in boost function, here ventilation zone 2.

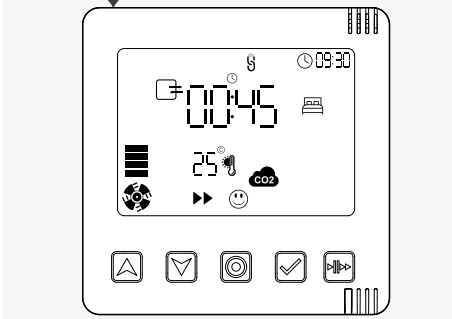

⇒ Alternating with the zone status, the remaining boost time is displayed.

The set boost time is displayed alternately with the zone status until it expires.

3.8 Acknowledging warnings / notifications

If necessary, the system informs you about events, e.g. low battery levels, or errors that have occurred, e.g. a failed system update.

The following notifications and errors may occur:

| Notification (✉) | Error (⚠ and LED on the controller flashes RED) | |
|--|---|---|
| Description | Code | Description |
| At least one ventilation device/sensor is switched off | F 01 | Time and date on the controller not set or not confirmed |
| Battery status of the Indoor/Outdoor sensors is low (< 20 %) | F 02 | At least one ventilation device/sensor is no longer reachable |
| Rel. room humidity limit value exceeded | F 03 | Firmware update failed |
| Limit value for CO ₂ content of indoor air exceeded | F 04 | Battery status of the Indoor/Outdoor humidity/temperature sensors is low (< 10 %) |
| Filter change due soon | F 05 | Switching contact triggered or switching contact is out of operation |
| System cleaning due soon | F 06 | Filter change required |
| | F 07 | System must be cleaned |

Table 5: Error codes

Notifications

If the system reports a message, the message symbol appears on the controller's display screen.

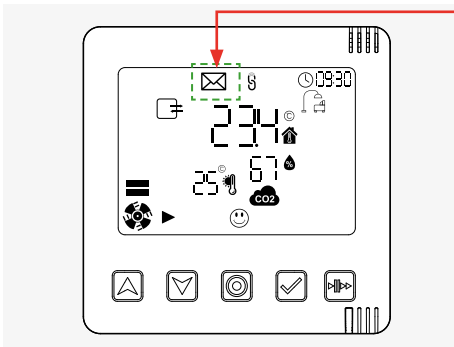

⇒ The message symbol appears on the display screen.

If the message symbol is enabled, you can only read the messages using the app.

The message symbol is displayed on the home screen until the notification reason is resolved. This may require an action (e.g. battery replacement) or occur automatically (e.g. limit value exceeded). It expires after the event has been rectified.

► If necessary, remove the reason for notification.

⇒ The message symbol goes out.

Warnings / Errors





If the system reports an error, the warning triangle symbol appears on the controller's display screen. Note the following restrictions:

- An error code can only be displayed on the controller as long as the LED is flashing. After the error code has been displayed once, it is deleted. At the same time, the LED stops flashing. If the error has not been eliminated, but only the error code has been deleted, the warning triangle symbol remains active (until the error has been eliminated). The error can then only be read with the "inVENTer Mobile" app, no longer on the controller.
- Each error code is displayed only once, even if the error occurs in the system on more than one component. Example: The system update has failed on four inner covers, but the controller only displays F03 once, not four times

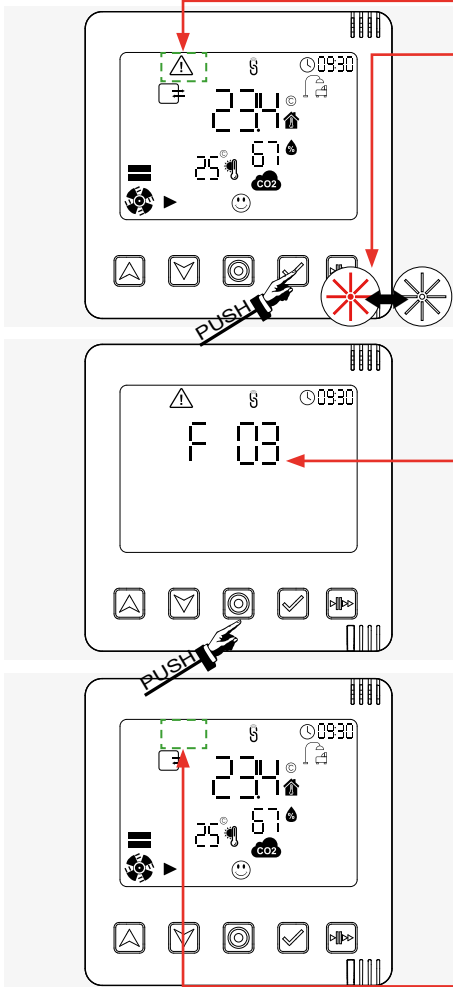
Requirements:

- The warning triangle symbol appears on the controller display screen.
- The LED on the controller flashes RED / WHITE alternately.





- ▶  Press the select key to display the error code.
 - ⇒ The error code is displayed on the display screen.
 - ▶  Press the select key again to display more error codes, if necessary.
 - ⇒ **Error code changes:**
Other errors have occurred in the system. To display all errors, press the select key repeatedly until the error code no longer changes.
 - ⇒ **Error code does not change:**
No other errors present in the system.
 - ▶  Press the mode key to confirm the error display.
 - ⇒ All error codes are deleted.
The flashing LED on the controller goes out.
 - ⇒ The display screen shows the zone status.
- If the error codes are cleared/acknowledged but the error has not been corrected, the warning triangle symbol continues to be displayed on the start screen. It goes out after the error has been corrected.
- ▶ Eliminate the cause of the error (e.g.  5: Cleaning,  7: Troubleshooting).
 - ⇒ The warning triangle symbol goes out.

3.9 Resetting the controller and devices

In order to set up the system again, it may be necessary to reset the Easy Connect e16 controller to its delivery status. Devices that are already paired (inner covers, sensors) are deleted. After resetting the controller, these must also be reset and then paired with the controller again.

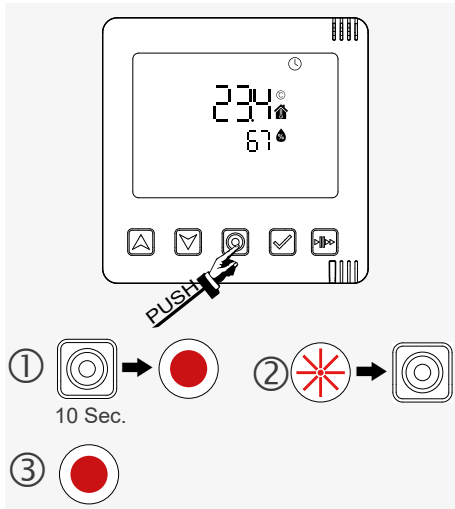
• Controller



▶  Press and hold the mode key until the LED lights up solid RED. (approx. 10 seconds) (1).

▶ Release the mode key.

⇒ The LED flashes RED for approx. 10 seconds.

▶  Press the mode key again within these 10 seconds to confirm the reset procedure.



⇒ The LED lights up permanently RED. (3)

⇒ The complete start routine then runs as described for commissioning.

• Inner cover



Tool (pin Ø 2 mm / 50 mm long), e.g. screwdriver

 First of all, the closing flap must be removed ( 3.2: Initial setup).

▶ Press the button using a small screwdriver and hold it until the LED is permanently red (approx. 10 seconds).

▶ Release the button.

⇒ The LED flashes RED for approx. 10 seconds.

▶ During these 10 seconds, press the button on the inner cover again to confirm the reset procedure.

⇒ The LED lights up permanently RED.

⇒ The complete start routine then runs as described for commissioning.

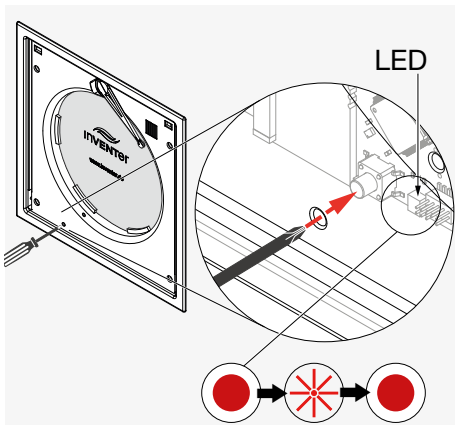

The steps for resetting described below apply equally to all other components (sensors, switching contact).

• FTS19-Connect Indoor humidity/temperature sensor

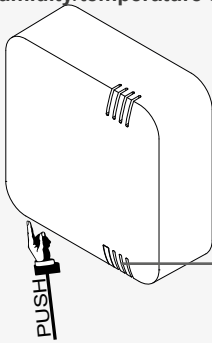

• FTS19-Connect Outdoor humidity/temperature sensor

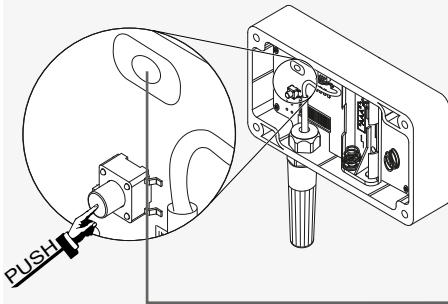

• CS2-Connect CO₂ sensor
• SK19-Connect switching contact

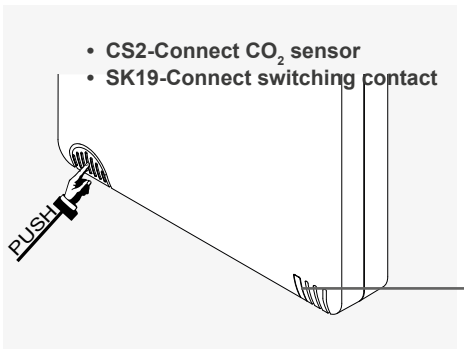

- ▶ Press and hold the button until the LED lights up solid RED. (1)
- ▶ Release the button.
- ⇒ The LED flashes RED for approx. 10 seconds. (2)
- ▶ During these 10 seconds, press the button on the
 - Indoor humidity/temperature sensor (on the underside of the housing)
 - or
 - Outdoor humidity/temperature sensor (in the housing)
 - or
 - CO₂ sensor
 - or
 - Switching contact
 again to confirm the reset procedure.
- ⇒ The LED lights up permanently RED. (3)
- ⇒ The complete start routine then runs as described for commissioning.

Brief overview



⇒ The system is now ready for reconfiguration.

The reset devices must then be re-paired with the Easy Connect e16 controller to be included in the system again (3.3: Pairing sensors).

4 Operation and setup with the app

The most convenient way to operate the inVENTer Connect system is with the "inVENTer Mobile" app. This is why mainly this form of operation is described here.

To connect the app to the controller, Bluetooth must be enabled and the app must be given location access.

4.1 Adding the controller to the app

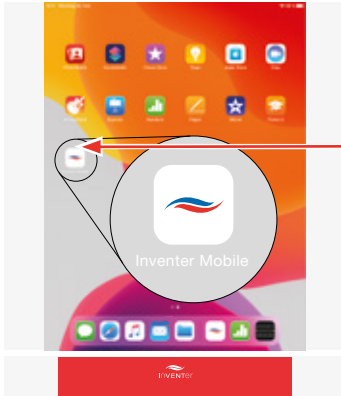

- ▶ Download the "inVENTer Mobile" app to your mobile device (mobile phone or tablet with Android or iOS operating system).

The app is obtained:



- ⇒ After successful installation of the app, the corresponding icon appears on the display screen.



Enable Bluetooth and location on your mobile device if these functions are disabled.

- ▶ Touch the "inVENTer Mobile" app icon on the display screen of your mobile device.

- ⇒ The start screen appears.

- ▶ Touch the START button.

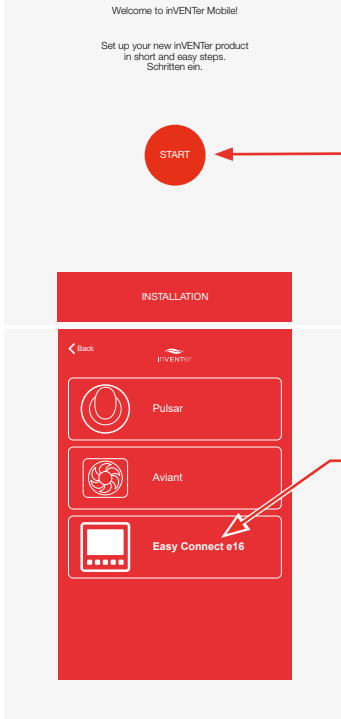

- ⇒ A window appears with a selection of devices that can be paired with your mobile device if necessary.

- ▶ Select the "Easy Connect e16" button here.

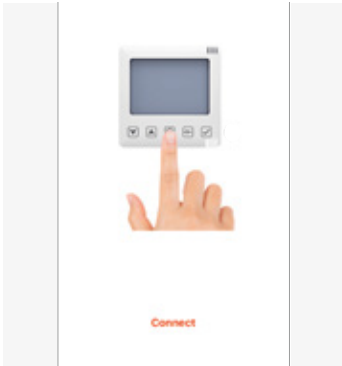

⇒ The display screen shows the request to pair with the controller.

To use the app, a Bluetooth connection must first be established between the controller and the mobile device. Please bear in mind the Bluetooth range.

Establish a Bluetooth connection by:

▶ pressing the mode key on the controller until the LED turns BLUE, then release it.

⇒ The LED on the controller flashes BLUE and the Bluetooth connection can be established.

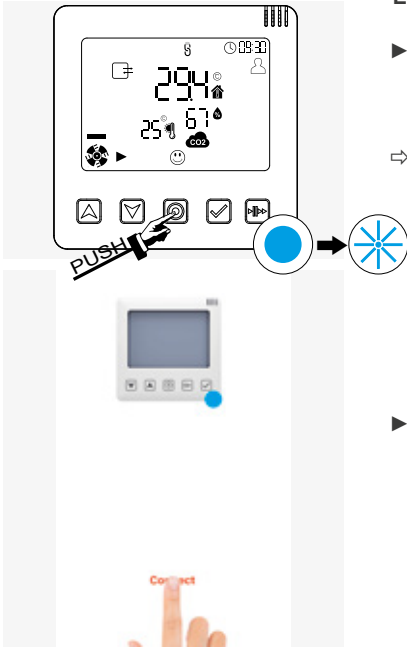

▶ While the LED on the controller is flashing BLUE, press the "Connect" button on your mobile device.

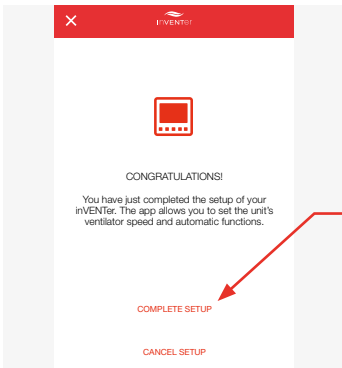

⇒ The controller and mobile device connect.

⇒ A message appears when the connection is completed.

▶ Press "Complete setup".

⇒ A new window opens.

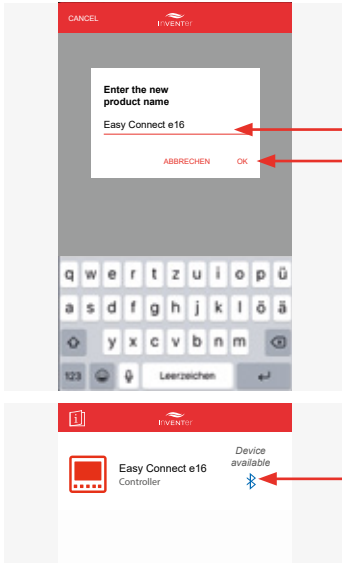

► Enter a name. This is freely selectable and can consist of a maximum of 20 characters.

Or:

Keep the inVENTer product name for the controller.

► Press "OK".

⇒ The controller appears on the display screen to indicate that it is connected and available.

The Bluetooth symbol appears in blue.

4.2 The screen of the app

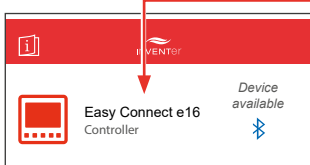

After pressing the area with the available controller, the window below (start menu) appears with the possible menus:

- Ventilation zone summary
- Device overview
- Advanced settings

All settings can be made in a menu.

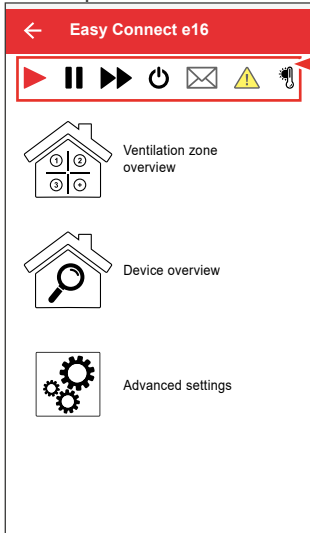

The navigation bar contains cross-zone control and information

 Auto symbol: Automatic operation according to the ventilation profile setting.

 Pause symbol: Quick selection of pause for the system

 Boost symbol: Quick selection of boost for the system

 Switch symbol: Quick selection of ON/OFF for the system

 Message symbol: System notifications

 Warning symbol: Display of error messages

 External temperature and humidity sensor symbol: Outdoor temperature is displayed (if installed).

4.3 "Device overview" menu

Once all the desired components have been linked to the controller and thus integrated into the system (for component pairing see  3.3), they are displayed in the device overview.

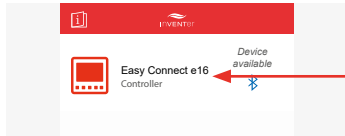

Requirements:

- The controller is included and available in the app.

▶ Press the "EasyConnect e16" button; your individual product name may be displayed here.

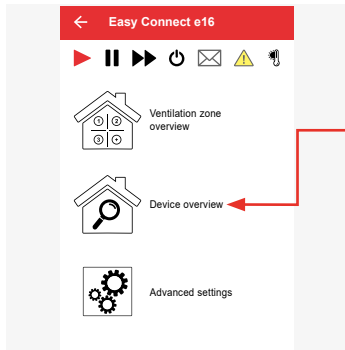

⇒ The Start menu opens.

▶ Press the "Device overview" button.

⇒ The "Device overview" window opens.

The "Device overview" menu item can be opened at any time to obtain information on the paired components.

The controller, as the central control unit, is always displayed as the first device and is automatically assigned to ventilation zone 1.

The devices are displayed in the order in which they were paired and are designated device 1, device 2, device 3, etc. This numbering corresponds to the numbering stuck on them during the pairing process and makes allocation easier.

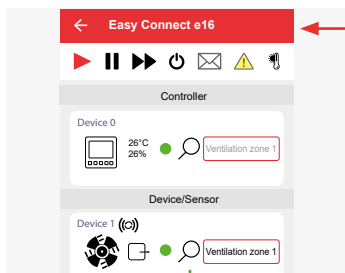

The following informations are displayed for each device:

Device name
(initially "Device", this can be changed later)

Device symbol

Device status

Availability

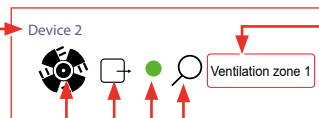

Allocated ventilation zone
(Text in black if the ventilation zone can be changed, grey if the ventilation zone is set by the system)

Device identification



Example screen:
All paired devices active

The following **device symbols and statuses** are displayed as soon as the associated component is paired:

| Symbol | Status | Paired component |
|--------|-----------------|--|
| | 25,4°C 22,1% | Transmitted temperature and humidity |
| | | Fan with direction of rotation supply air |
| | | Fan with direction of rotation exhaust air |
| | | CO ₂ content Good |
| | | CO ₂ content Slightly raised |
| | | CO ₂ content Too high |
| | | Switching contact active |
| | | Switching contact triggered |
| | 25,4°C 22,1% | Transmitted temperature and humidity |
| | 25,4°C 22,1% | Transmitted temperature and humidity |

The following displays are possible in the **Availability** area:

- Green colour: a component is integrated in the system and active,
- Yellow colour: a connected component is not accessible due to an error.

Other symbols:

| Symbol | Meaning |
|--------|--|
| | Strength of the radio signal currently present. |
| | "Radio signal weak": It is recommended to use a signal amplifier (repeater, 4.10) for the paired device. |
| | Device acts as a signal amplifier (repeater) for another device in the system |
| | Device identification |

4.4 Device identification

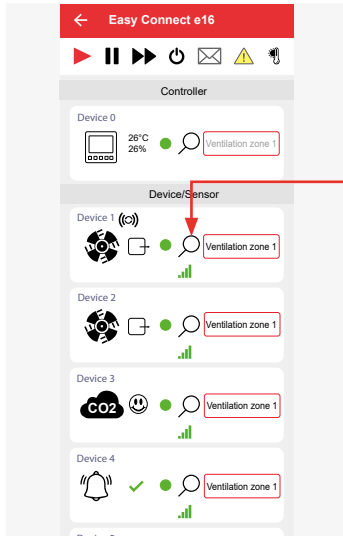

A system component can be identified by clicking on the identify symbol (magnifying glass). This is necessary, for example, if a device is to be renamed but it is unclear which device it is. Device identification cannot be carried out for battery-operated components (Indoor / Outdoor humidity/temperature sensor).

Requirements:

- You are in the "Device overview" menu.

➔ Press the Identify icon of the component whose location you want to know.

⇒ Component is found:

The LED on the corresponding component flashes alternately PURPLE and YELLOW.

Or

⇒ Component is not found:

Step 1: If necessary, use a signal amplifier (repeater) (📖 4.10).

Step 2: If this does not help, perform a reset of the corresponding device (📖 3.9: Resetting the controller and components) and reconnect the device.

4.5 Renaming components

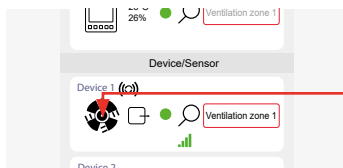

Requirements:

- You are in the "Device overview" menu.
- The component is identified, if necessary (📖 4.4)

➔ Press the symbol of the component you want to rename.

⇒ The adjacent window opens. The software version and the strength of the radio signal are displayed.

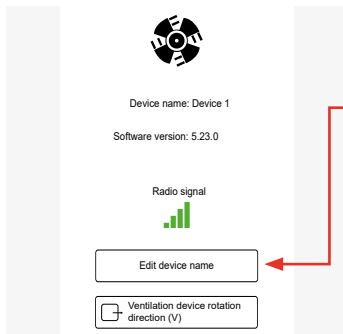

➔ Press the "Edit device name" button to edit the device name.

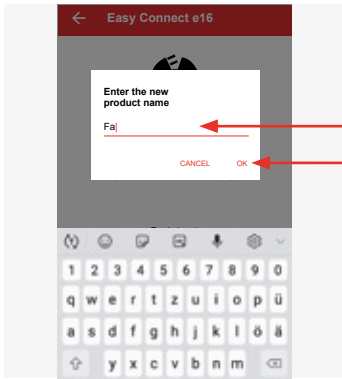

- ⇒ The adjacent window opens.
- ▶ Enter the new name for the selected device. This is freely selectable and can consist of a maximum of 16 characters, e.g. Fan 1 or Living room.
- ▶ Confirm the new name by pressing "OK".

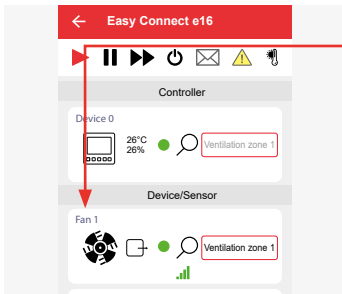

- ⇒ The renamed device appears in the device list with its new name.
- ▶ Continue renaming the devices. Identify the components for this, if necessary.

4.6 Changing the direction of rotation of the fan

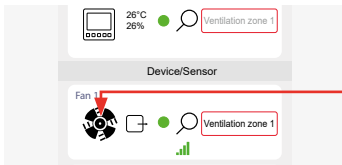

Requirements:

- The ventilation device is in unidirectional ventilation operating mode (supply air or extract air).

- ▶ Press the symbol of the fan whose direction of rotation you want to change.

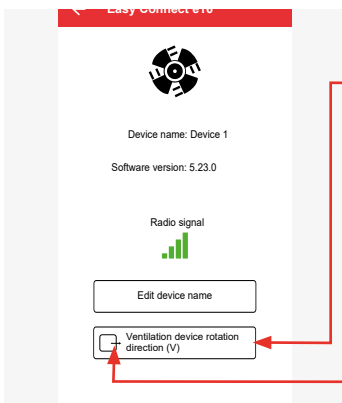

- ⇒ The adjacent window opens.
- ▶ Press the "Ventilation unit roataion direction (DL)" button.
- ⇒ The small arrow changes direction, indicating that the fan's direction of rotation has been changed in unidirectional ventilation mode. The selected fan then takes on a different role (e.g. supply air instead of extract air). The system automatically ensures that a balance is maintained between supply and extract air.

4.7 Assigning devices to the ventilation zones

- By default, all devices are assigned to ventilation zone 1.
- The controller is automatically assigned to ventilation zone 1 and cannot be assigned to another zone.
- The Outdoor humidity/temperature sensor and switching contact are assigned to all zones and cannot be assigned to a specific zone.
- The other components can be assigned to one of the four ventilation zones defined in the system.

Note: When assigning the ventilation zones, operation of the ventilation devices in pairs must be observed (at least 2 ventilation devices per ventilation zone and an even number).

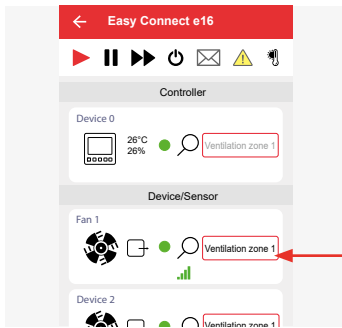

Requirements:

- You are in the "Device overview" menu.



TIP:

You can assign a ventilation zone other than ventilation zone 1 to the ventilation units during setup. You can also change this assigned ventilation zone again at any time.

- ▶ Press the "Ventilation zone" button (ventilation zone 1 or the one already assigned, different from 1).

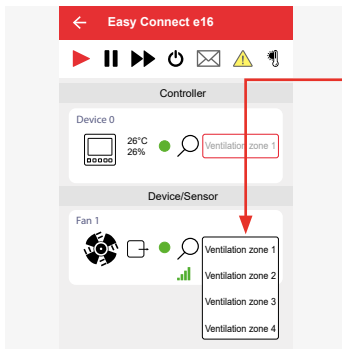

- ⇒ A selection window opens in which the 4 ventilation zones are displayed.

- ▶ Press the ventilation zone to be assigned to the selected device.

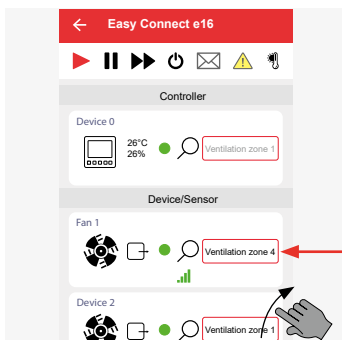

- ⇒ The newly assigned ventilation zone is displayed in the device overview (here ventilation zone 4 as an example).

- ▶ Scroll through the displayed device overview and continue to assign or change the ventilation zones as described.

- ⇒ Once all devices have been assigned to the desired zones, they are displayed in the "Device overview" with the respective new ventilation zone.

4.8 Defining ventilation zones and their properties

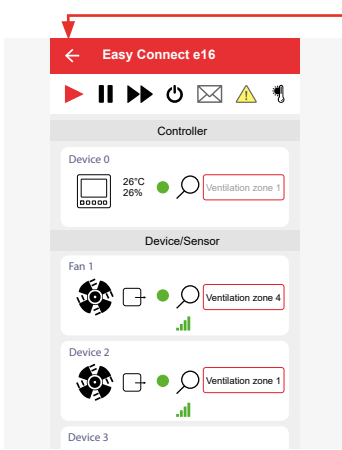

- ▶ Press the "Back" symbol to return to the Start menu (window with the possible menus)
- or
- ▶ Call up the Start menu as described (📖 4.2: Screen of the app).

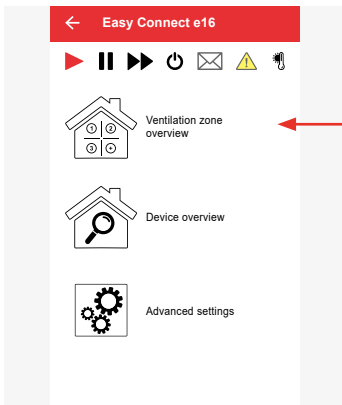

- ⇒ The Start menu opens.
- ▶ Press the "Ventilation zone overview" menu item in this window.

The "Ventilation zone overview" menu item can be opened at any time to change settings for the ventilation zones.

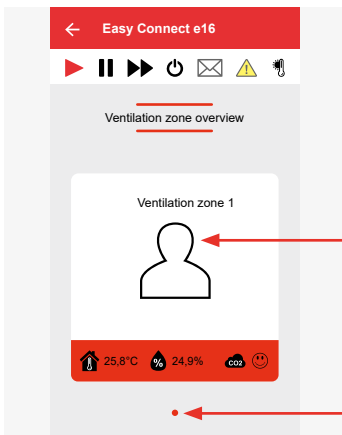

- ⇒ The "Ventilation zone overview" menu opens.
- ▶ Press the tile of the ventilation zone.

A dot indicates that only one ventilation zone has been defined so far.

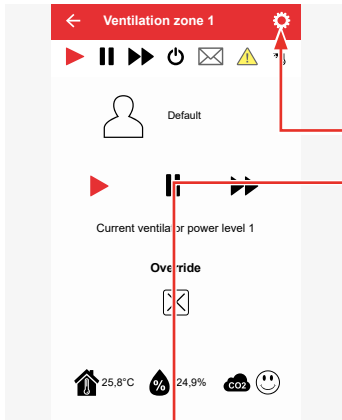

- ⇒ The adjacent window opens, in which
- the properties of this ventilation zone are displayed.
 - settings for this ventilation zone can be changed.

Press the "Settings" button.

⇒ A new selection window opens. The following settings can be made or changed:

- Ambient humidity

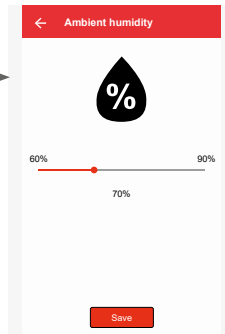

You can change the humidity limit by moving the slide control. Then press "Save".

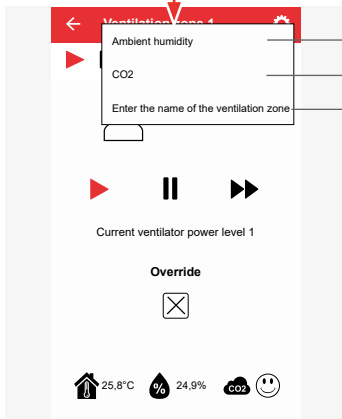

- CO₂

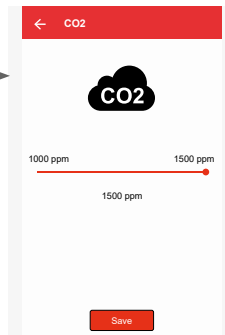

You can change the CO₂ limit by moving the slide control. Then press "Save".

Limit recommendations are:
 Pettenkofer: 1000 ppm
 General minimum requirement: 1500 ppm

- Name of the ventilation zone

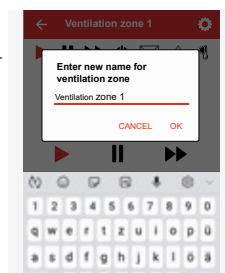

If desired, enter a new name for the selected ventilation zone. This is freely selectable and can consist of a maximum of 16 characters.

Press "OK" and confirm the new name.

Assigning a ventilation profile to the ventilation zone

Requirements:

- The window in which settings can be made for the selected ventilation zone is displayed.

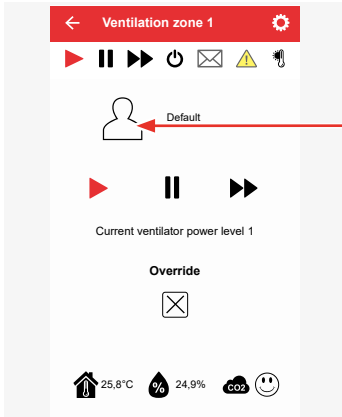

▶ Press the profile symbol.

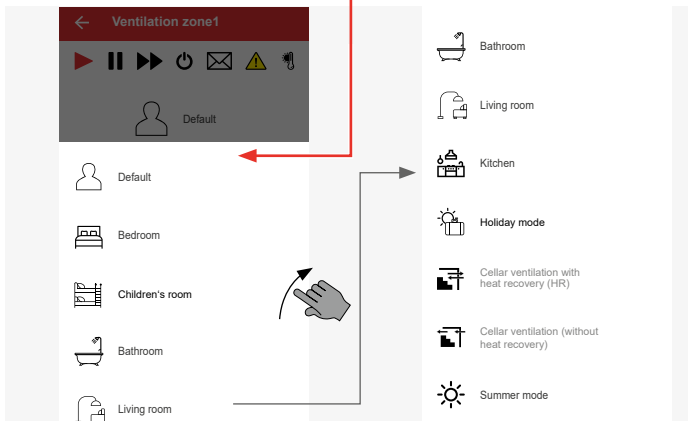

⇒ A selection window with the possible ventilation profiles appears.

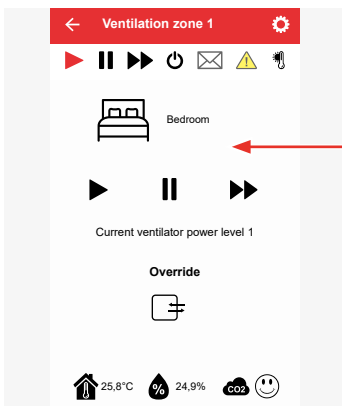

▶ Press a ventilation profile to select it.

⇒ The window for ventilation zone 1 appears, to which another ventilation profile is now assigned.

View of the ventilation zones

You can view the ventilation zones that have been defined at any time and change settings if necessary.

Example:

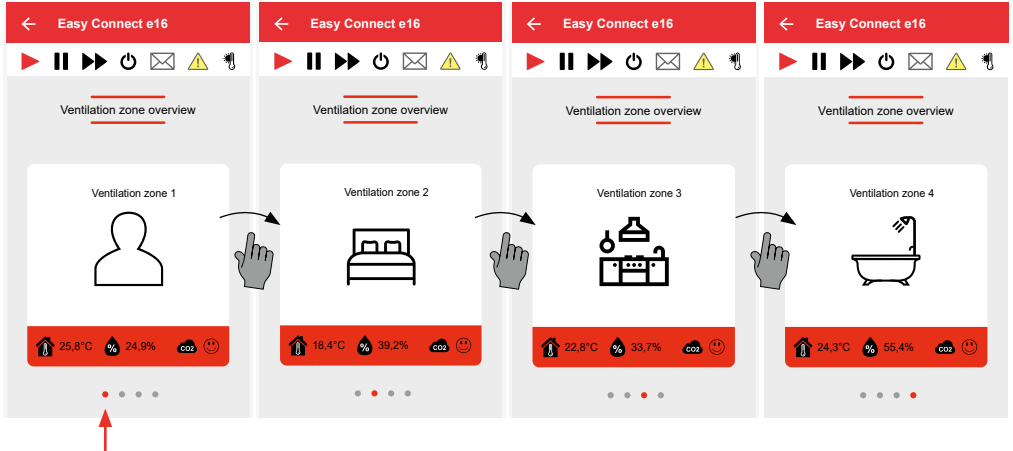

⇒ 4 ventilation zones are defined. The red dot shows which ventilation zone is currently selected.

▶ Tap on the symbol of a ventilation zone.

⇒ The window opens in which the following values for this zone are displayed:

- Ventilation profile
- Ventilation level (fan speed)
- Ventilation mode (operating mode)

and where you can change these settings by overriding them.

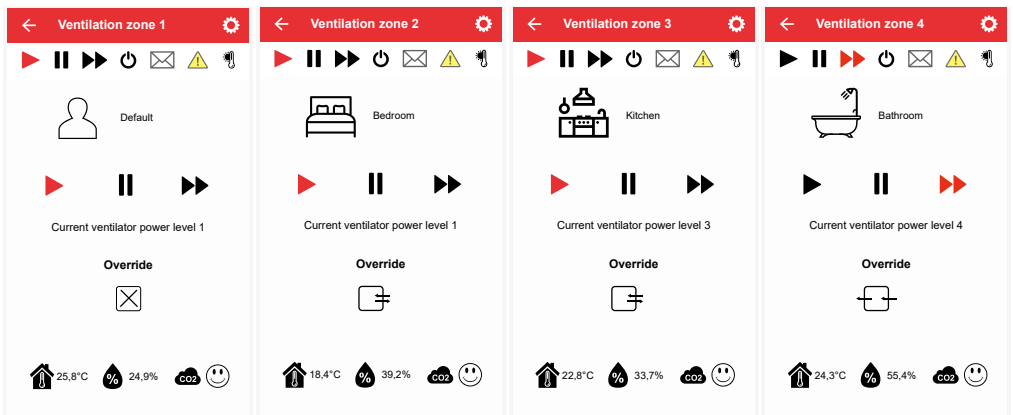

Setting the ventilation mode and ventilation level

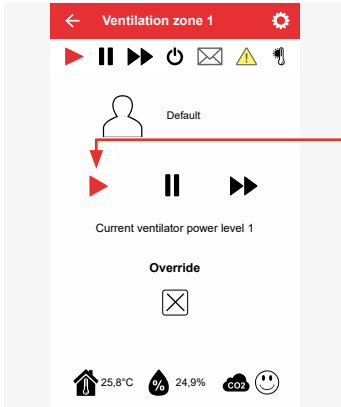

Requirements:

- The window in which settings can be made for the selected ventilation zone is displayed.

⇒ The fan runs in automatic mode (Auto; ventilation mode).

The active mode is indicated by a red symbol.

The following manual changes (overrides) of the set ventilation profile are possible:

Option 1: Pause mode

Option 2: Boost mode

Option 3: Change ventilation level and ventilation mode

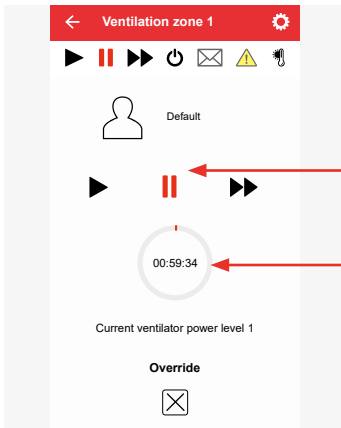

Option 1: Pause mode

▶ Press the Pause button  in the active window and put the ventilation unit into pause mode.

⇒ Pause mode is selected. The pause symbol is displayed in red.

⇒ A countdown appears on the screen to show how long the ventilation zone is still in pause mode.

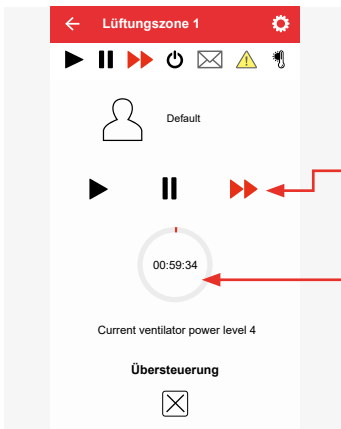

Option 2: Boost mode

▶ Press the Boost button  in the active window and put the ventilation zone into boost mode.

⇒ Boost mode is selected.
Ventilation level 4 is set.
The boost symbol is displayed in red.

⇒ A countdown appears on the screen to show how long the ventilation zone is still in boost mode.

Option 3: Change the ventilation level and ventilation mode (override ventilation profile)

The fan speed and operating mode can be manually overridden for a specified time. To do this, press the "Override" button.

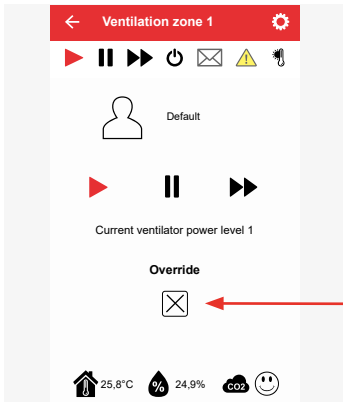

▶ Press the ventilation symbol or the "Override" button. Here, for example, Fan mode OFF.

⇒ The adjacent window opens.

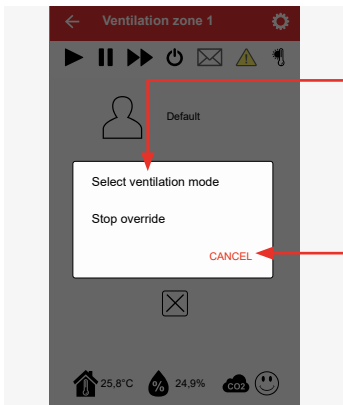

▶ Press the "Select ventilation mode" button here to change the current ventilation mode, or press "Stop override" to stop manual intervention of the ventilation profile and return to the current ventilation mode.

▶ Pressing "Cancel" cancels the manual override option.

⇒ If you have selected "Select ventilation mode", the window below opens where you can change the ventilation mode.

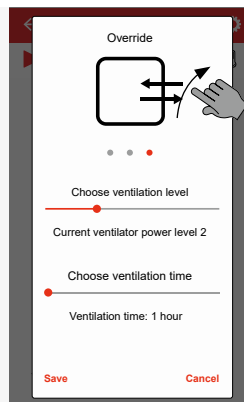
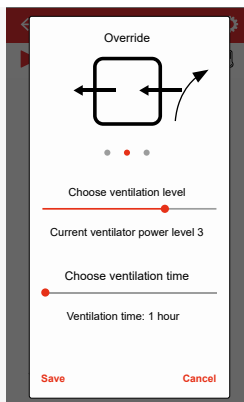
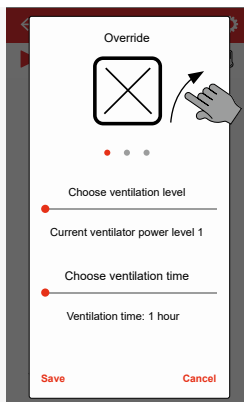

By swiping across the screen, you change ventilation modes:

- OFF
- Unidirectional ventilation
- Heat recovery

► If the desired ventilation mode appears on the screen, you can make the desired settings; e.g.:

⇒ The selected ventilation mode is "Ventilation with heat recovery":

► Operate the slide control and set the desired ventilation level. When setting the ventilation level, you can choose between 4 levels.

► Operate the slide control and set the desired ventilation time. When setting the ventilation time, you can choose between 1, 2, 4 and 8 hours.

► When the desired values are set, press this button to save the settings.

⇒ The system runs with the settings you have changed manually.

Ventilation zone for which the settings have been changed.

Display of the remaining time for manual override.

Ventilation mode now "Ventilation with heat recovery".

► When all the desired settings have been completed, press the "Back" button.

⇒ You return to the "Ventilation zone summary" window.

► Press the "Back" button again to return to the Start menu.

⇒ Other settings can be made, such as advanced settings.

4.9 Advanced settings



NOTICE

The advanced settings include in-depth adjustments to the system and can have a significant impact on the performance and operating principle.

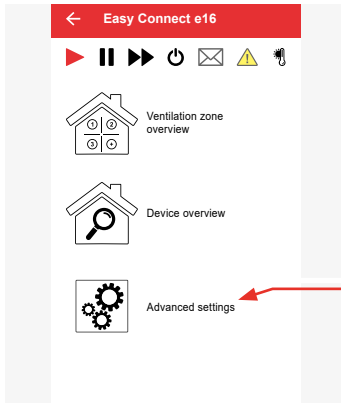

⇒ The starting point is the start menu of the app.

▶ Press The "Advanced settings" button.

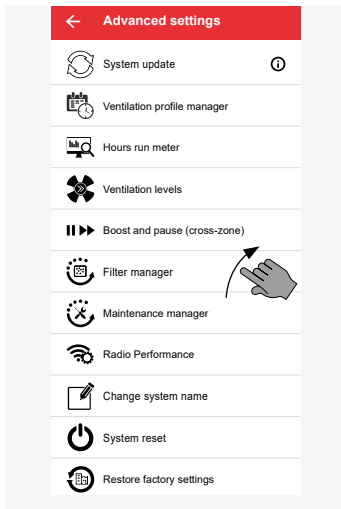

⇒ The window on the left opens and the possible advanced settings are displayed:

- System update 📖 p. 64
- Ventilation profile manager 📖 p. 67
- Operating hours counter 📖 p. 71
- Ventilation levels 📖 p. 71
- Boost and Pause (cross-zone) 📖 p. 72
- Filter manager 📖 p. 73
- Maintenance manager 📖 p. 75
- Radio performance (repeater) 📖 p. 77
- Changing the system name 📖 p. 78
- System reset 📖 p. 79
- Restoring factory settings 📖 p. 80

By tapping on a menu item, the corresponding menu opens and you can make advanced settings.

System update



NOTICE

The software update takes some time. You cannot use your mobile device for any other purpose during data transmission. Please allow sufficient time before you initiate the update.



NOTICE

Before each system update, check the charging status of battery-operated devices in the device list. If the battery charge level is not green, the batteries must be replaced before the system update to avoid a malfunction of the system update.

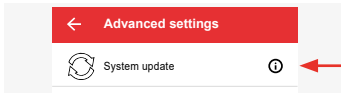

If you press the information symbol or the "System update" button, the software versions of your devices are displayed, e.g. for the Easy Connect e16 controller.

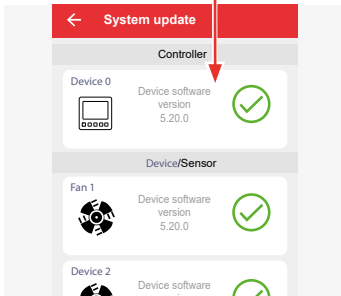

Requirements:

- There are new software versions for the devices in your ventilation system.

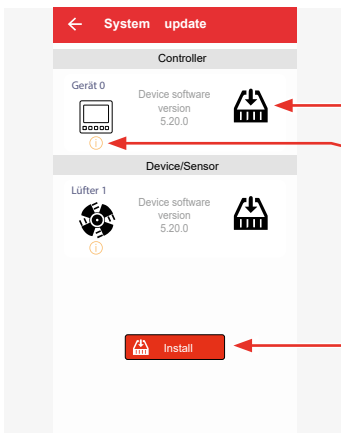

▶ Press the "System update" button.

⇒ The adjacent window opens.

⇒ The download symbol appears next to the device.

⇒ The information symbol informs you that a new software version is available.

If you want to update your system, install the new software version. To do this:

▶ Press the "Install" button.

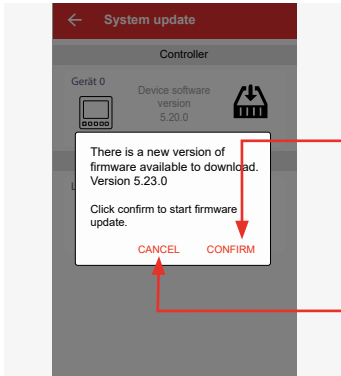

⇒ The adjacent window opens.

▶ Press the "Confirm" button to confirm the download

or

▶ Press the "Cancel" button to not start updating the software.

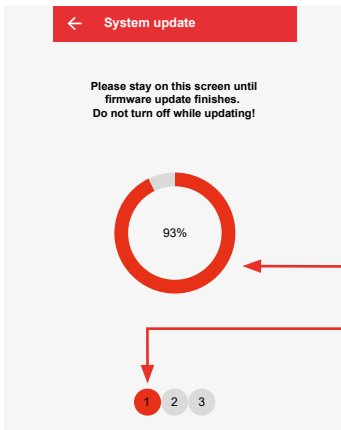

⇒ The current software version is downloaded and transferred to the controller.
The progress is displayed as shown in the adjacent window.



NOTICE:

Stay in this menu item and never close the app!

Display of the progress when transferring the new software version to the controller.

Display of the total number of devices for which a new software version is transferred to the controller.

Red indicates for which device group transmission is currently in progress:

- ① Controller
- ② Connect inner cover
- ③ Sensors

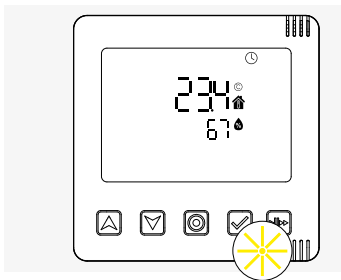

First, the current software version for the controller is transferred. The LED on the controller flashes YELLOW.

When the transfer of the new software version for the controller is 99% complete, the LED on the controller briefly lights up BLUE.

When the transfer of the new software version for the controller is fully complete, the LED flashes YELLOW again.

The new software version for the next device group is transmitted to the controller.

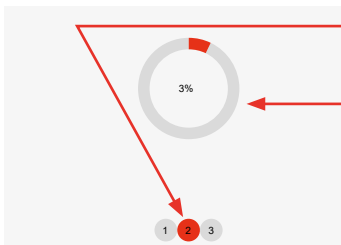

⇒ On the app screen, the next circle turns red and the progress bar shows the transfer status for this device.

The software is automatically transferred until the new software version for all components in the system has been transferred to the controller.

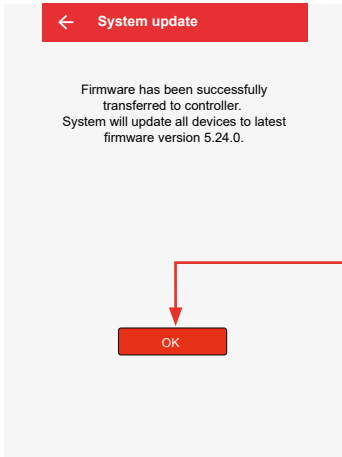

⇒ When the transfer of the new software is complete, the adjacent window opens.

- ▶ Press the "OK" button to confirm the software update.
- ⇒ The software is updated.

First, the controller software is updated. When this is complete, the controller transmits the information for the software update to all system components in turn.

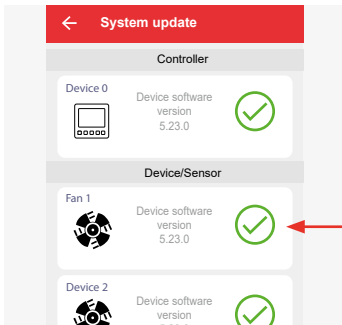

- ⇒ During the software update, the LED flashes YELLOW on the device that is being updated.
- ⇒ The initial screen for the system update opens, showing the progress of the software update (see grey text box below).
- ⇒ Once the software update is complete, your system components are displayed with the latest software version.

You can check the progress of the software update or view the software status at any time by opening the initial screen for the system update. To do this:

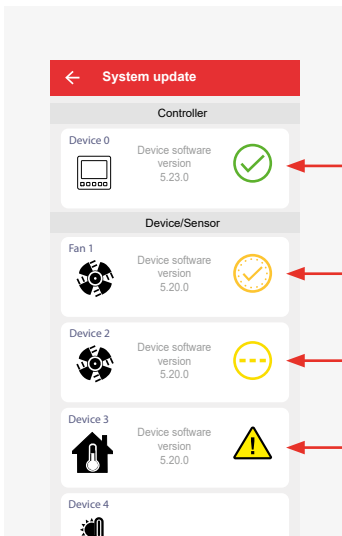

▶ Press the "Advanced settings" button as described, and then press "System update".

⇒ The adjacent window opens and displays:

▶ The software update has been successfully completed.

▶ The software update is in progress.

▶ Waiting for the software update.

▶ An error has occurred and the software update could not be successfully performed or completed. The system will try the update again at a later time.

Ventilation profile manager

Here you have the option to make changes to the existing ventilation profiles to adapt them to your personal requirements.

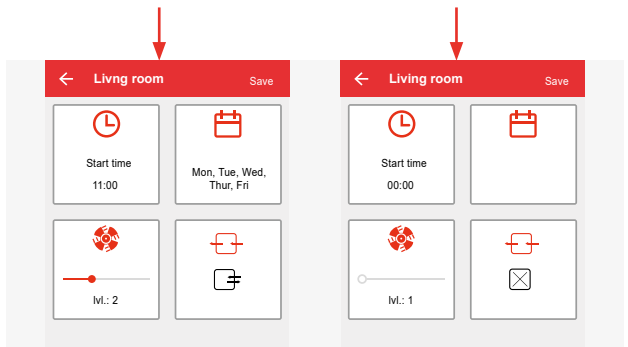
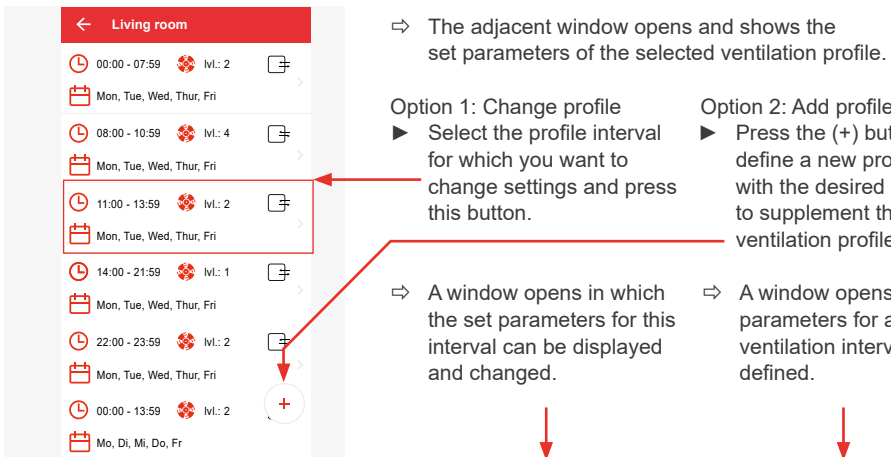
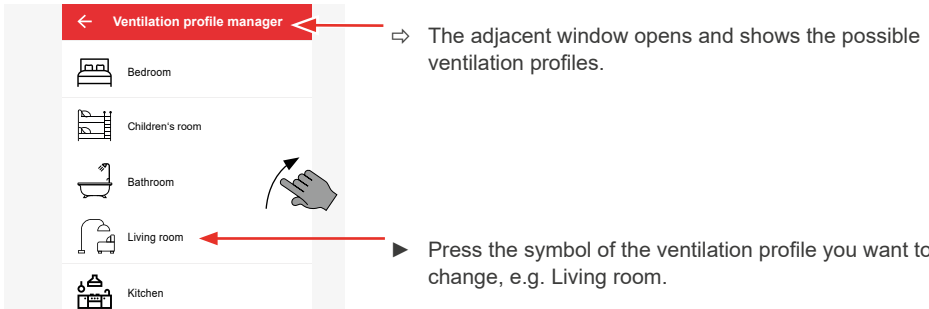

The following parameters can be defined or changed:

The steps for defining or changing the parameters are identical. Changing parameters is described below.

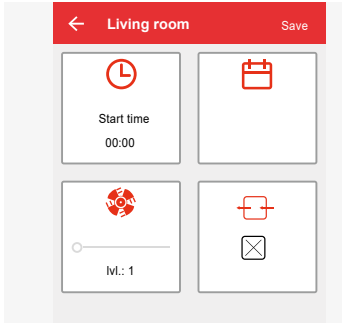

Start time (from when the setting is to take effect)



Weekday (on which weekdays the settings apply)



Fan level (levels 1 to 4)



Ventilation mode (through-ventilation, heat recovery, OFF)

The button where you are making settings is outlined in red.

Start time

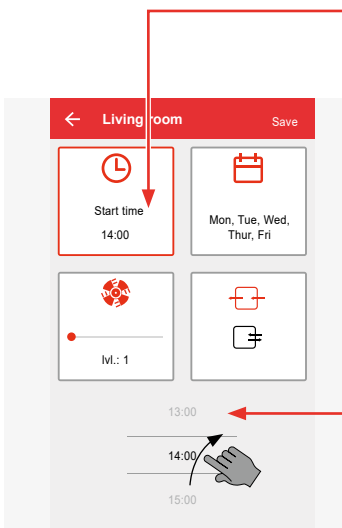

▶ If you press the "Start time" button, a timeline is displayed. Here you can change or redefine the start of a time interval. The end time is automatically limited by the machine to the next time interval. If there is no subsequent interval, the interval is automatically extended to the end of the day (23:59).

⇒ The "Start time" tile shows the currently scrolled time.

▶ When the desired start time is reached, stop scrolling.

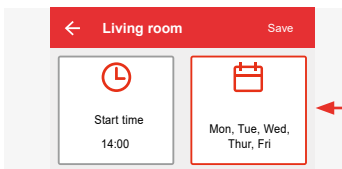

▶ Press the next button to select the day(s) of the week on which the settings are to take effect.

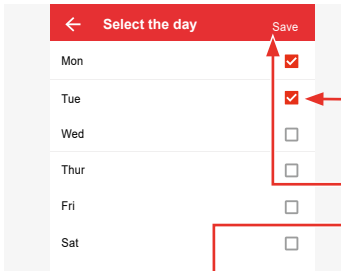

- ⇒ In the window that opens, click on the desired day(s) of the week. The selected days are marked with a tick.
- ▶ Press "Save". You will automatically return to the window with the setting options.

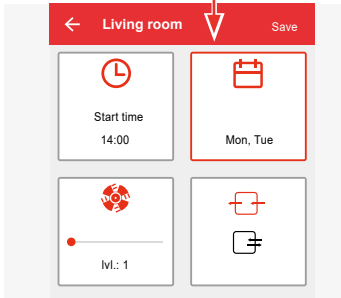

- ⇒ The set values for the start time and weekday are displayed.
- ▶ Now change the ventilation level and/or ventilation mode, if desired.

Ventilation level

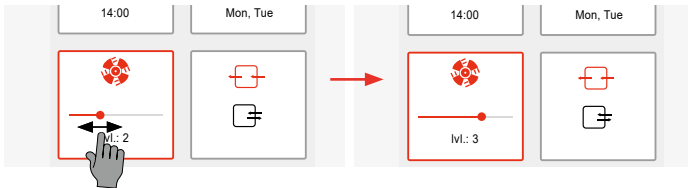

- ▶ Change the ventilation level by pressing the slide control and dragging it to the desired level.

Ventilation mode

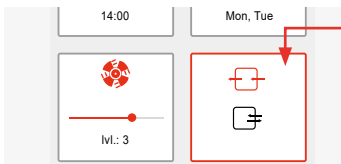

- ▶ Change the ventilation mode by pressing the "Ventilation mode" button.
- ▶ Scroll across the screen in the window that then opens to be shown the possible ventilation modes in succession.

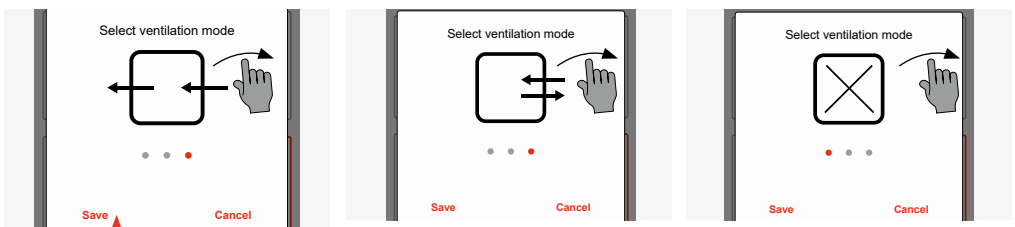

- ▶ Press "Save" on the desired ventilation mode.

After pressing "Save", you will automatically return to the window with the setting options.

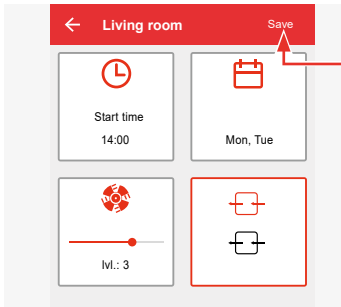

⇒ The settings you have specified are displayed.

▶ If the settings shown correspond to your requirements, press "Save".

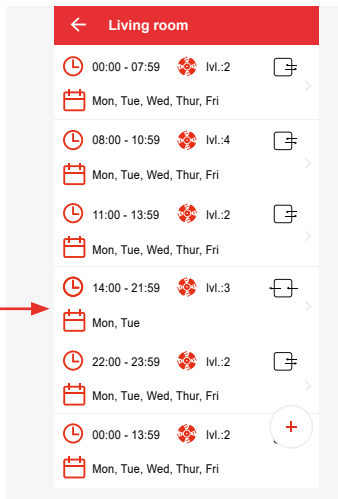
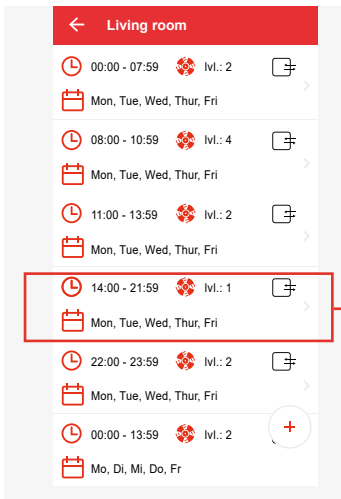

⇒ The set values are transferred to the ventilation profile or, in the case of changes in an existing profile period, changed. Here in the example, the period from 14:00.

Removing a profile interval from a ventilation profile

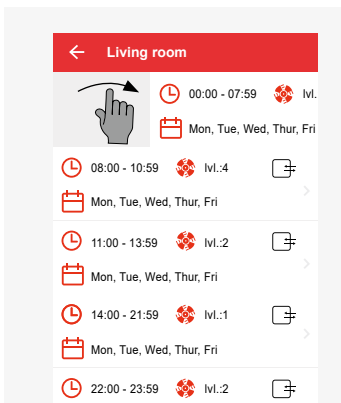

TIP: Profile intervals can be removed from a ventilation profile.

▶ "Swipe" the profile interval you want to remove from the screen area.

⇒ The profile interval is removed from the ventilation profile. The previous interval takes over the period of the deleted interval.

Operating hours counter

This shows you how many hours the ventilation devices in your ventilation system that are connected to the controller have been in operation.

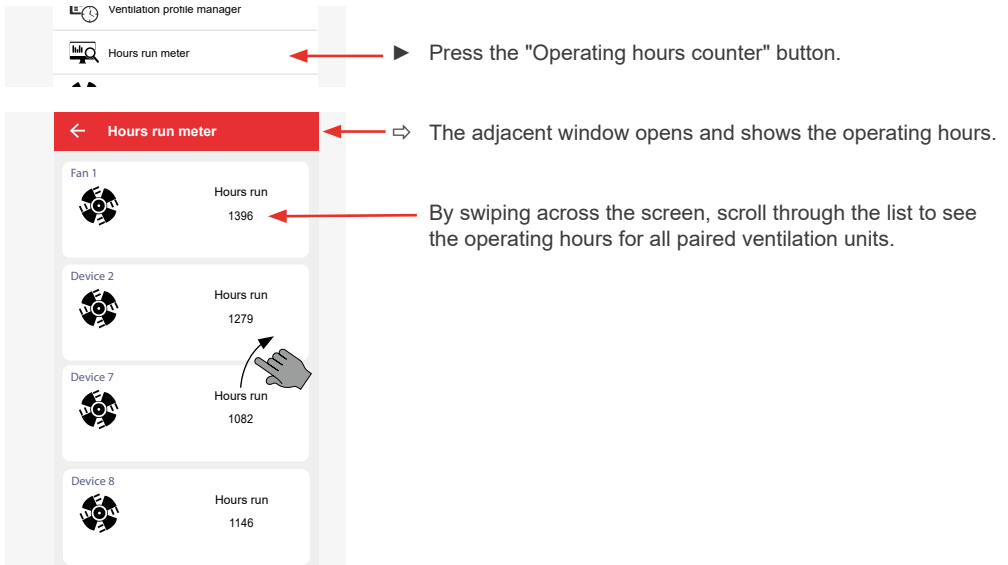

Ventilation levels

In this menu you can change the values for the factory-set fan speeds.

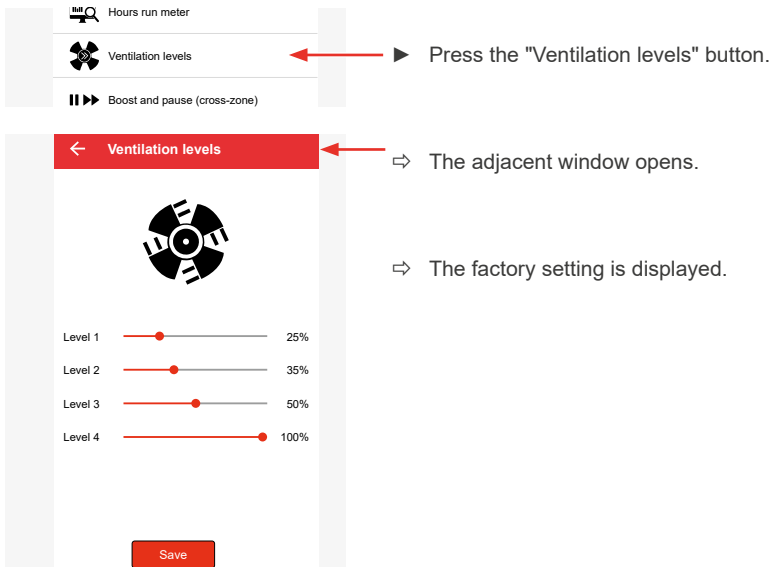

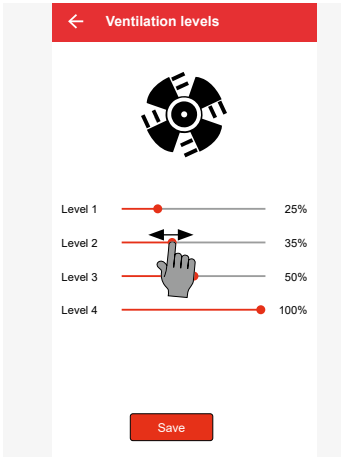

- ▶ At a selected level, press the slide control and drag it to the desired value.

Values below 25% are not possible.

- ▶ Press "Save".
- ⇒ The ventilation units deliver the air flow according to your specified values.

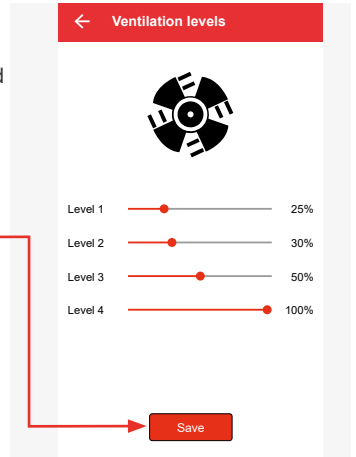

Boost and pause (cross-zone)

Here you can change the duration of boost and pause. The change is effective for the global boost and pause function and affects all ventilation zones.

The factory setting for boost and pause is one hour.

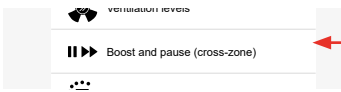

- ▶ Press the "Boost and Pause (cross-zone)" button.

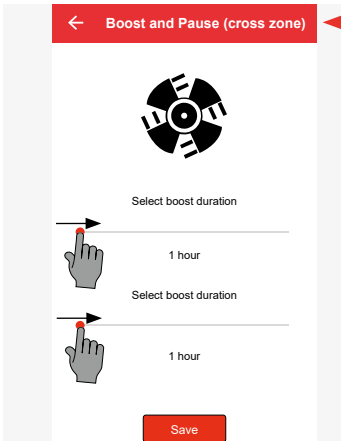

- ⇒ The adjacent window opens. The factory setting is displayed.

- ▶ Press a slide control and drag it to the desired time. The duration of boost and pause can be set to 2, 4 or 8 hours instead of the factory setting.

- ▶ Press "Save".
- ⇒ Your settings for the duration of boost and pause are used for the cross-zone boost and pause function.

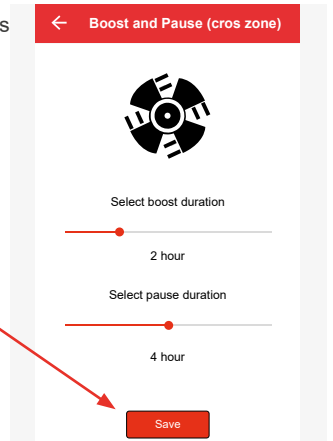

Filter manager

Here you are shown how many months are left before the filter in the ventilation system needs to be changed. The factory setting for the filter change interval is 6 months.

Once the ventilation system has been set up, the app automatically counts the months remaining until the scheduled filter change.

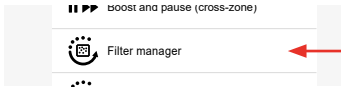

▶ Press the "Filter manager" button.

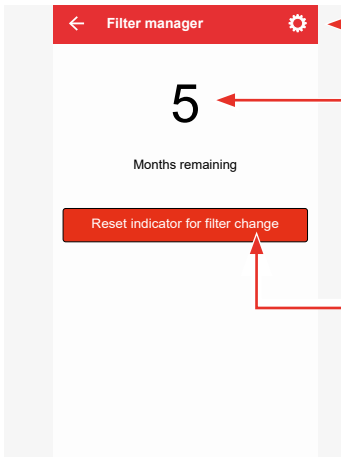

⇒ The adjacent window opens and displays the months remaining until the scheduled filter change.

Resetting the filter change interval

If you have already changed the filter off schedule or for other reasons, you can reset this interval.

▶ To do this, press the "Reset indicator for filter change" button.

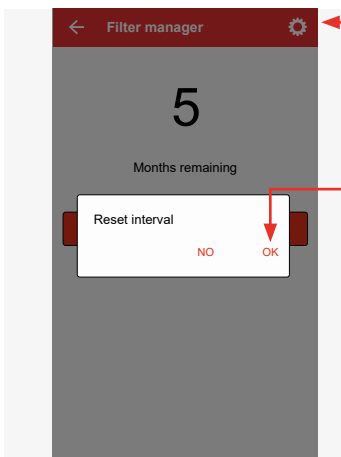

⇒ The adjacent window opens.

▶ Press "OK" to confirm the reset or "NO" to cancel.

⇒ After "OK", the interval until the filter change is reset to the factory setting (6 months) or your personal setting.

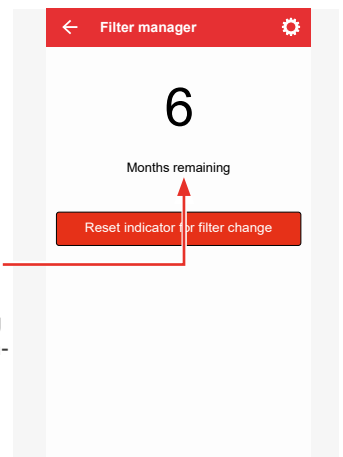

Setting the filter change interval individually

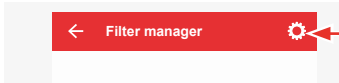

▶ To do this, press the "gear symbol" in the filter manager.

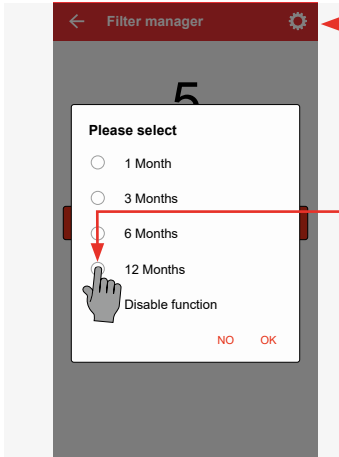

⇒ The adjacent window opens, in which you can set the desired interval by tapping.

▶ To do this, press the desired interval, e.g. 12 months.

⇒ The corresponding circle is marked red.

▶ Confirm the setting with "OK" or cancel it by tapping "NO".

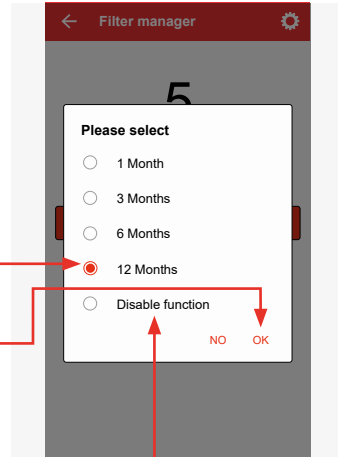

Press this button to disable the filter manager.

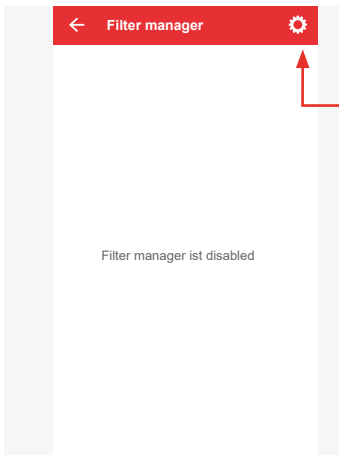

⇒ If the function has been disabled, this is indicated by the adjacent window when you enter the filter manager in Advanced settings.

By pressing the "gear symbol" (see above), you can cancel the deactivation by selecting an interval for the filter change again and confirming the selection with "OK".



TIP:

The following filter maintenance and replacement intervals are recommended:

- Dust filter: 3 months
- Pollen filter: 1 month
- Activated carbon filter: 6 months

Maintenance manager

Here you are shown how many months are left before general maintenance of all of the devices integrated into the ventilation system needs to be carried out.

The factory setting for the maintenance interval of your ventilation units is 6 months.

Once the ventilation system has been set up, the app automatically counts the months remaining until the scheduled maintenance.

Press the "Maintenance manager" button.

The adjacent window opens and displays the months remaining until the scheduled maintenance.

5
Months remaining

Reset interval

TIP:
If you have carried out maintenance work off schedule or for other reasons, you can reset this interval.

To do this, press the "Reset interval" button.

The adjacent window opens, asking you to confirm that unit maintenance has been carried out.

5
Months remaining

Device maintenance carried out
NO OK

Press "OK" to confirm the device maintenance or "NO" to cancel.

After "OK", the remaining time is reset and the specified interval (factory setting or your personal setting) starts again.

6
Months remaining

Reset interval

You can also set the maintenance interval individually.

← Maintenance manager

▶ To do this, press the "gear symbol" in the maintenance manager.

⇒ The adjacent window opens, in which you can set the desired interval by tapping.

▶ To do this, press the desired interval, e.g. 12 months.

⇒ The corresponding circle is marked red.

▶ Confirm the setting with "OK" or cancel it by tapping "NO".

Press this button to disable the maintenance manager.

← Maintenance manager

⇒ If the function has been disabled, this is indicated by the adjacent window when you enter the maintenance manager in Advanced settings.

TIP: By pressing the "gear symbol" (see above), you can cancel the deactivation by selecting a maintenance interval again and confirming the selection with "OK". Refer to the instructions of the respective ventilation unit for the required maintenance interval.

Maintenance manager disabled

Radio performance (repeater)

Using this function, you can determine whether a system component integrated into the ventilation system is to be used as an amplifier of the radio signal in addition to the controller to improve the radio connection between the components within the ventilation system.

Use this function if the radio signal of the controller does not reliably reach all devices integrated in the ventilation system.

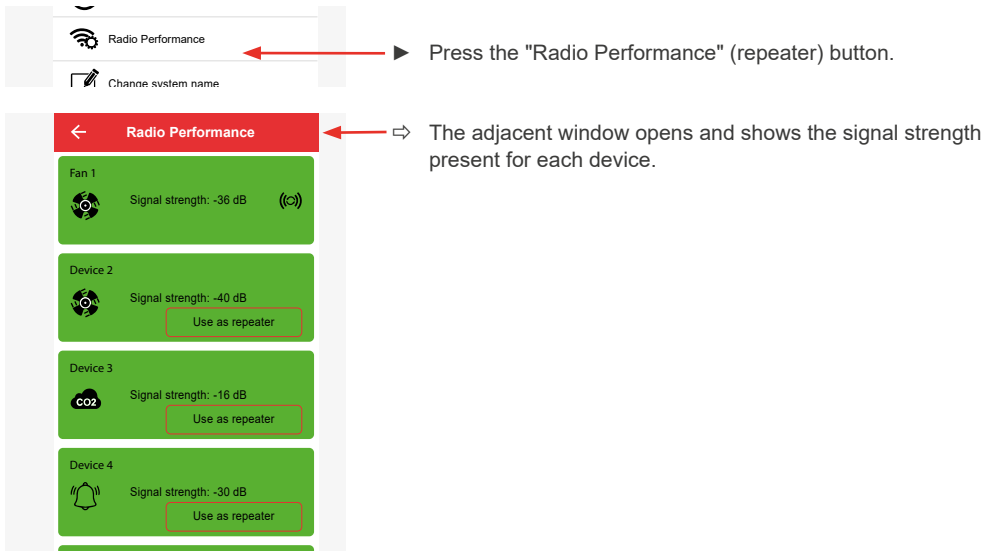

The menu allows you to set a paired device as a signal amplifier for other Connect devices that are/will be integrated into the system.

The exact procedure can be found in [📖 4.10: Setting up the component as a signal amplifier \(repeater\)](#).

Changing the system name

Here you can change the name of your inVENTer Connect controller platform (factory setting: "Easy Connect e16").

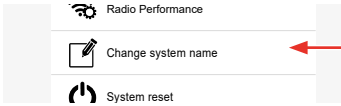

Press the "Change system name" button.

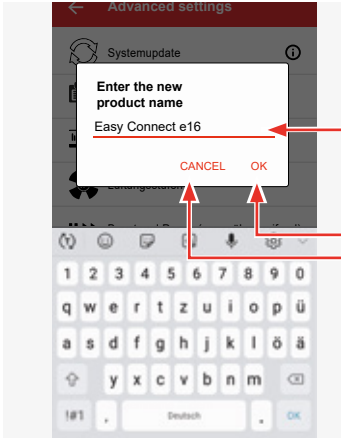

The adjacent window opens.

Enter a new name using the on-screen keyboard. This is freely selectable and can consist of a maximum of 20 characters.

Confirm your entries with "OK" or cancel the renaming process by tapping "CANCEL".

System reset

In this menu, you have the option of resetting the Easy Connect e16 controller and all device connections.

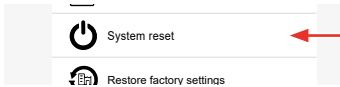

▶ Press the "System reset" button.

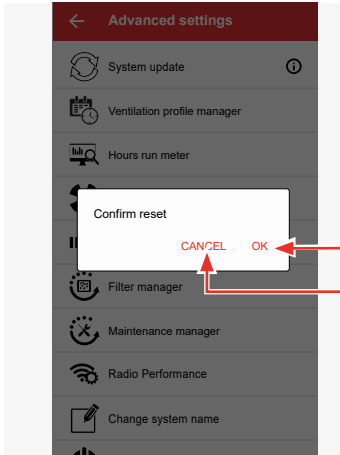

⇒ The adjacent window opens in which you are prompted to confirm the reset.

▶ Press "OK" to confirm the reset or cancel the reset by tapping "CANCEL".

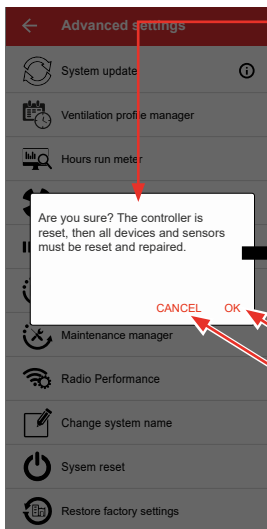

⇒ If you have confirmed the reset with "OK", you are asked again whether you want to reset the system.

Are you sure? The controller is reset, then all devices and sensors must be reset and repaired.

CANCEL **OK**

▶ If you are sure, confirm the reset by pressing "OK".
or
press "CANCEL" and cancel the reset.

⇒ The system is reset.

▶ Reset all units and sensors and commission the system again as described (📖 3.2: Initial set-up and 3.3: Device pairing).

Restoring factory settings

Here you can reset the individual settings of your inVENTer Connect controller platform to the factory settings.
Device pairings remain in place.

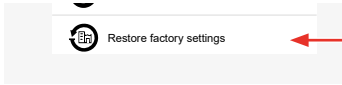

▶ Press the "Restore factory setting" button.

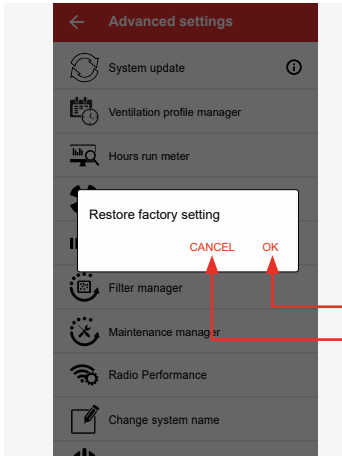

⇒ The adjacent window opens asking you to confirm that the factory setting is to be restored.

▶ Press "OK" to confirm the restoration of the factory setting or cancel the process by tapping "CANCEL".

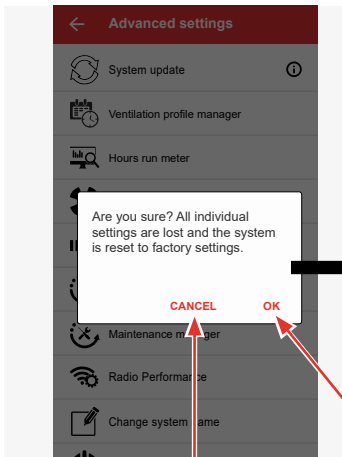

⇒ If you have confirmed the restoration of the factory setting with "OK", you are asked again whether you want to restore the factory setting.

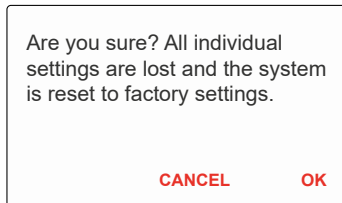

▶ If you are sure, confirm the restoration of the factory setting by pressing "OK".
or
press "CANCEL" and cancel the process.

⇒ The system is reset to the factory setting.

▶ Restore personal settings if necessary.

4.10 Setting the device as a signal amplifier (repeater function)

Using this function, you can determine whether a system component integrated into the ventilation system is to be used as an amplifier of the radio signal in addition to the controller in order to improve the radio connection between the devices within the ventilation system.

A paired device can be set up as a signal amplifier (repeater) for another device in two ways:

- via the "Device overview" button, or
- via the "Advanced settings" button.

Setting the device as a signal amplifier via the "Device overview"

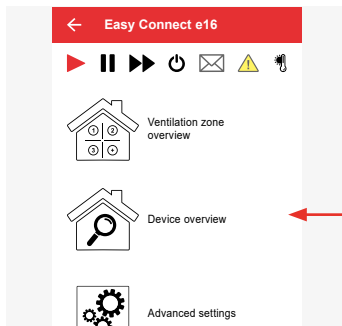

When setting up via the "Device overview" button, the user selects a device that requires signal amplification. The controller system searches for possible repeaters.

⇒ The starting point is the start menu of the app.

▶ Press the "Device overview" button.

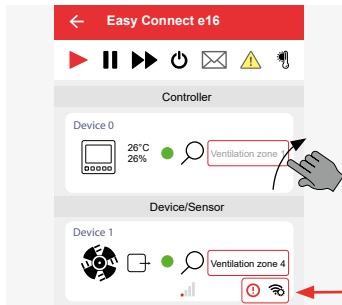

⇒ The adjacent window opens.



TIP:

Swipe the screen to scroll through the "Device list" menu and view the status of the radio signal for all paired devices.

▶ Press the "Radio signal weak"  symbol.

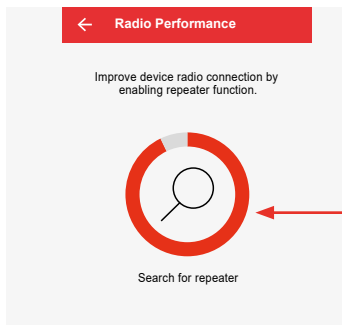

⇒ An internal search is made for devices that are available as signal amplifiers for the device.

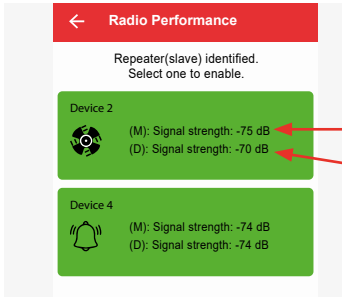

- ▶ Select the device that is to act as a signal amplifier from the suggestions. In this case:
 - M: the signal strength to the Easy Connect e16 controller
 - D: the signal strength to the component that needs signal amplification.

Select the device that has the best signal strength to the controller (M) to obtain a long-term stable connection. If several devices are suggested as possible repeaters, the topmost device rated as the most suitable by the app.

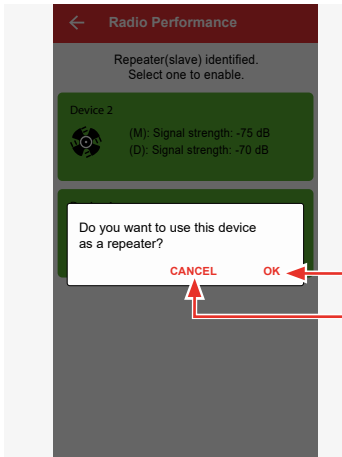

- ⇒ The adjacent window opens asking you to confirm that the device / sensor is to be used as a signal amplifier.
- ▶ Press "OK" to confirm the device as a signal amplifier (repeater), or cancel the process by tapping "CANCEL".

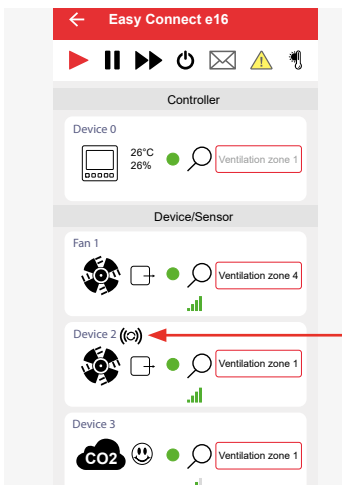

- ⇒ The selected device is used as a signal amplifier (repeater).
- ⇒ Next to the device set as a repeater, the corresponding symbol (Ⓢ) is displayed to indicate that the device is acting as a signal amplifier.

Within a controller system, several devices can be set as signal amplifiers (repeaters). The corresponding symbol appears next to each device specified as a signal amplifier. We recommend keeping the number of repeaters in the system low.

Setting the devices as a signal amplifier via the advanced settings

When setting up via the "Advanced settings" button, the devices are assigned manually, i.e. the device that is to act as a signal amplifier can be defined by the user.

⇒ The starting point is the "Advanced settings" menu in the app.

▶ Press the "Radio Performance" button.

⇒ The adjacent window opens and shows the signal strength for each device:

- **Green:** good signal strength (> -80 dB), Device is already being used as a repeater (symbol((C))), or can be used as a repeater
- **Yellow:** poor signal strength / no signal (< -80 dB): signal amplification for the device in question is recommended (define repeater via the "Device overview" menu).

▶ Press the "Use as Repeater" button of the component that is to be set up as a signal amplifier in the system, e.g. Device 4.

⇒ The selected system component is used as a signal amplifier (repeater).

⇒ Next to the component set as a repeater, the symbol ((C)) is displayed to indicate that the device is acting as a signal amplifier.

Within a controller system, several devices can be set as signal amplifiers (repeaters). The corresponding icon appears next to each device specified as a signal amplifier. We recommend keeping the number of repeaters in the system low.

Removing the device as a signal amplifier (repeater)

⇒ The starting point is the "Advanced settings" menu in the app.

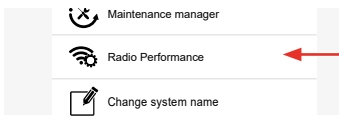

▶ Press the "Radio Performance" (repeater) button.

⇒ The adjacent window opens.

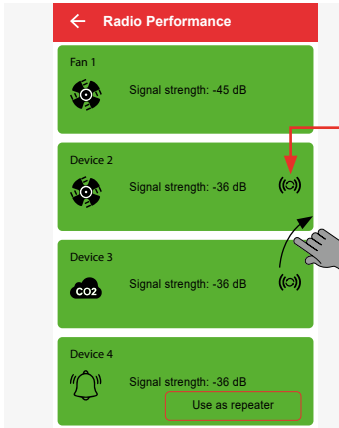

▶ Press the (📶) symbol of the device that is to be removed as a signal amplifier (repeater).



TIP:

By swiping across the screen, you scroll through the "Radio Performance (repeater)" menu and can see for each paired device whether it is activated as a repeater.

⇒ The adjacent window opens asking you to confirm that the device is no longer to act as a signal amplifier (repeater).

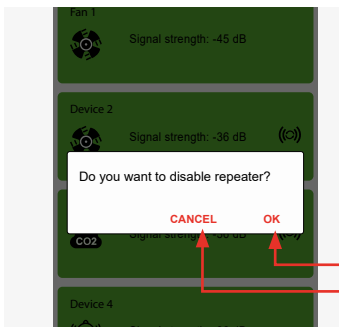

▶ Press "OK" to deactivate the device as a signal amplifier or cancel the process by tapping "CANCEL".

⇒ The selected device is deactivated as a signal amplifier (repeater).

⇒ Next to the device, the (📶) symbol disappears and is replaced by the button "Use as repeater".

5 Cleaning and care

5.1 Easy Connect e16 controller



CAUTION

Cleaning by children and persons with limited abilities.

Injury to persons and/or incorrect functioning of the ventilation system!

- No cleaning or maintenance activities may be performed on the ventilation system by children and/or persons who are not fully capable of safely doing so due to their physical, sensory or mental capabilities, inexperience or lack of knowledge.

The Easy Connect e16 controller is virtually maintenance-free.

Any servicing work required can be carried out by the user after brief instructions.



TIP:

Disconnect the power supply for any cleaning or care work.

Detergents



NOTICE

Due to the controller's scratch-sensitive plastic surface,

damage may occur to the surface.

- To prevent damage to the surface, do not use sand, soda, acid or chlorine-based cleaning agents.

A commercially available detergent in warm water can be used for cleaning.

The following tools may be used for cleaning:

- lint-free, soft cloth
- soft brush

Service recommendations

The servicing tasks and intervals listed here are recommended by inVENTer GmbH to maintain the functionality and performance of your controller.

Depending on requirements, your personal schedule may deviate from these recommendations.

| Interval | Module | Maintenance activity |
|---|---|---|
| Monthly | Easy Connect e16 controller | Clean surfaces with a damp cloth. Brush the ventilation slots clear. |
| If option selected: | | |
| Monthly or on demand (e.g. after battery change) | FTS19-Connect Indoor humidity/temperature sensor | Clean surfaces with a damp cloth. Brush the ventilation slots clear. |
| | CS2-Connect CO ₂ sensor | |
| | SK19-Connect switching contact | |
| | FTS19-Connect Outdoor humidity/temperature sensor | Clean surfaces with a damp cloth. |

Table 6: Maintenance recommendation

5.2 Connect inner cover



CAUTION

Cleaning by children and persons with limited abilities.

Injury to persons and/or incorrect functioning of the ventilation system!

- No cleaning or maintenance activities may be performed on the ventilation system by children and/or persons who are not fully capable of safely doing so due to their physical, sensory or mental capabilities, inexperience or lack of knowledge.

The housing and automatic closing flap of the inner cover are virtually maintenance-free.

Any servicing work required can be carried out by the user after brief instructions.

Clean or replace the dust filter (alternatively pollen or activated carbon filter) regularly. After care or replacement, make sure that you have inserted the filter correctly to avoid malfunctions of the ventilation unit.

Detergents



NOTICE

Due to the scratch-sensitive plastic surface of the inner cover,

damage may occur to the surface.

- To prevent damage to the surface, do not use sand, soda, acid or chlorine-based cleaning agents.

A commercially available detergent in warm water can be used for cleaning. The following tools may be used for cleaning:

- lint-free, soft cloth
- soft brush
- vacuum cleaner

Service recommendations

The servicing tasks and intervals listed here are recommended by inVENTer GmbH to maintain the functionality and performance of your inner cover. Depending on requirements, your personal schedule may deviate from these recommendations.

| Interval | Module | Maintenance activity |
|-------------|--|---|
| Monthly | Housing | Clean the surfaces with a damp cloth. |
| | Pollen filter (if available) | Replace the used filter. |
| Quarterly | Dust filter | Rinse the dust filter in warm water. Or Replace worn dust filters. |
| Half-yearly | Activated carbon filter (if available) | Replace the used filter. |

Table 7: Maintenance recommendation

The following installation steps are described using the flush-mounted version of the inner cover, but apply equally to the surface-mounted version.

Cleaning/replacing the dust filter | System cleaning

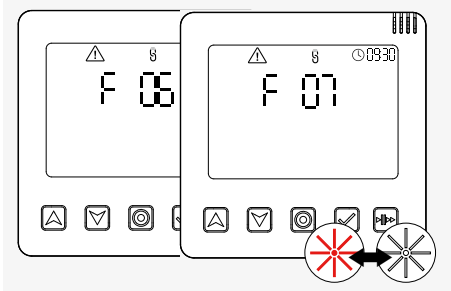

Requirements:

- The LED on the controller is flashing RED
- The error code F 06 (filter change required) or F 07 (service of the ventilation devices necessary) is displayed.
- The app reports in a message that the filter needs to be changed and/or the ventilation system needs to be serviced.



NOTICE: To clean and check the filter, first remove the closing flap on the inner cover. To do this, the entire ventilation system must be switched off at the controller or paused so that the closing flap's locking arm moves to the right. **Never swivel the locking arm by hand.**

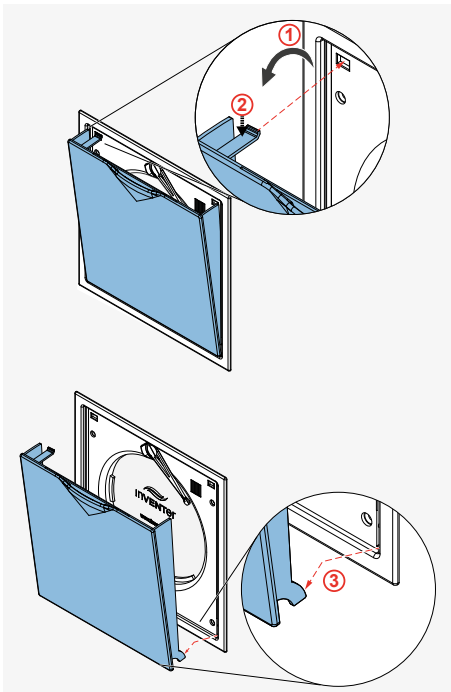

- ▶ Pause the ventilation device or switch it off (📖 3.6 [Controller] and/or 📖 4.2 | 4.8 [App]).

⇒ The swivel arm moves to the right.

- ▶ Pull the closing flap forward, away from the electronics cover (①).
- ▶ Press the spring clip at the top slightly downwards (②) so that it slides out of the opening when the electronics cover is pulled forwards.

- ▶ Lift the lower lugs out of the guide (③).

- ▶ Remove the closing flap from the front.

⇒ You have removed closing flap on the inner cover.

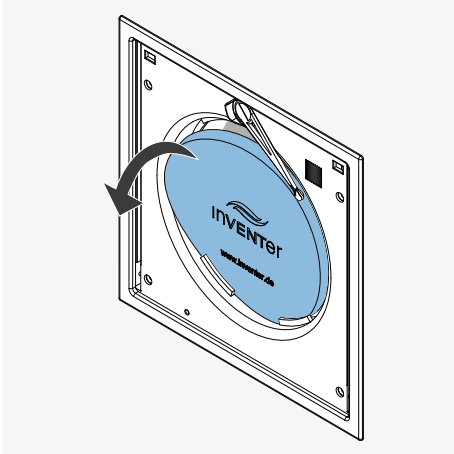

The inVENTer ISO Coarse 45 % dust filters are highly durable and can be rinsed repeatedly. We recommend cleaning the dust filter regularly and replacing worn filters. Pollen and activated carbon filters are available as accessories for special requirements. The respective removal/fitting for this is carried out in the same way as described here.

- ▶ Carefully pull the dust filter out of the filter holder on the electronics cover.

⇒ You have removed the dust filter.

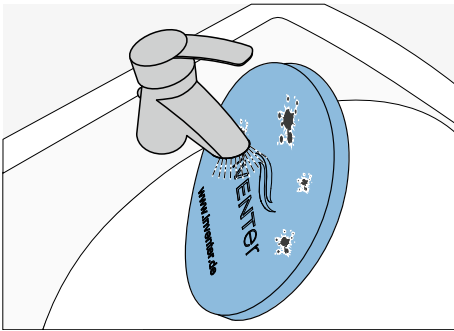

- ▶ Clean the dust filter under warm running water.
- ▶ Wait until the dust filter is completely dry.

⇒ You have cleaned the dust filter.

Or:

- ▶ Discard dust filters if they have defects and replace them with a new filter.

Error code 07:

When the dust filter has been removed, access to the ventilation unit is clear. Before replacing the dust filter, also clean the ventilation unit components with a vacuum cleaner and soft brush. Cleaning the ventilation units is also described in the installation instructions of the corresponding ventilation unit.

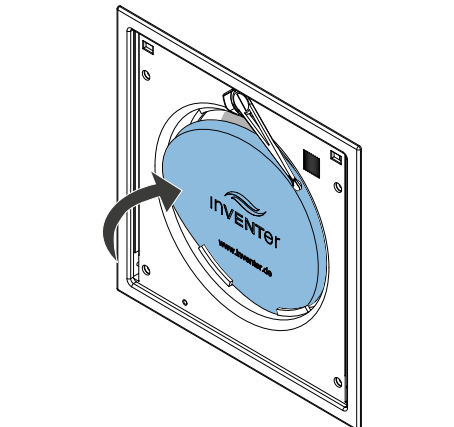

- ▶ Slide the completely dried or new filter (dust filter as standard, alternatively pollen or active carbon filter) behind the guides provided (filter holder) into the electronics cover.

👁️ ! Position the filter firmly between the filter holders.

⇒ You have cleaned / changed the dust filter.

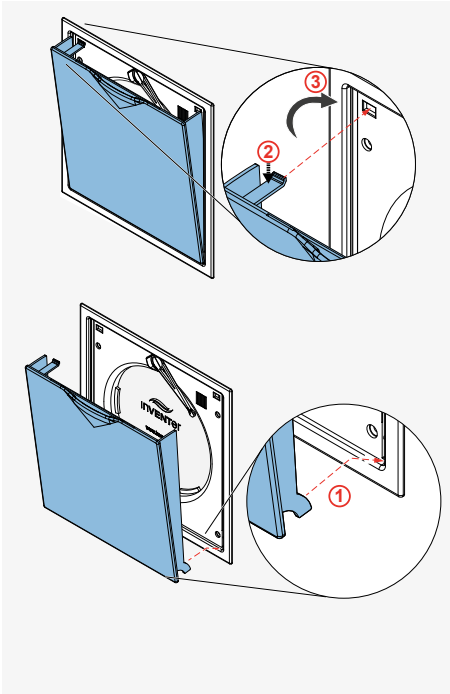

- ▶ Hook the lugs of the closing flap into the electronics cover at the bottom (1).
- ▶ Press the spring clip at the top slightly downwards (2).

- ▶ Guide the closing flap to the top of the electronics cover (3), pushing the slightly depressed spring clip into the opening provided in the electronics cover. The spring clip snaps into place, the closing flap is pulled and held by the magnets.

⇒ You have attached the closing flap.

- ▶ After all the closing flaps have been fitted, put the system back into operation using the controller or app.
- ▶ Reset the filter change interval/service interval in the app.

5.3 Sensor technology

The Indoor / Outdoor humidity/temperature sensor and the CO₂ sensor are virtually maintenance-free and such tasks are limited to external cleaning and, if necessary, battery replacement.

Detergents



NOTICE

Due to the scratch-sensitive plastic surface of the sensor technology, damage may occur to the surface.

- To prevent damage to the surface, do not use sand, soda, acid or chlorine-based cleaning agents.

A commercially available detergent in warm water can be used for cleaning.

The following tools may be used for cleaning:

- lint-free, soft cloth
- soft brush

Service recommendations

The servicing tasks and intervals listed here are recommended by inVENTer GmbH to maintain the functionality and performance of your sensor technology. Depending on requirements, your personal schedule may deviate from these recommendations.

| Interval | Module | Maintenance activity |
|-------------|--|---------------------------------------|
| As required | Housing | Clean the surfaces with a damp cloth. |
| As required | Indoor / Outdoor humidity / temperature sensor | Battery change |

Table 8: Maintenance recommendation

Battery change

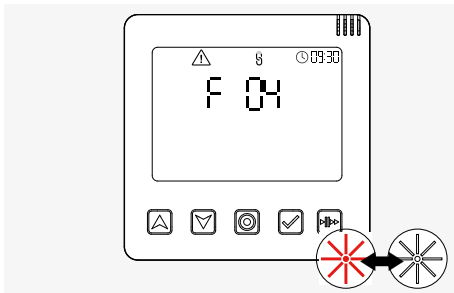

Requirements:

- The LED on the controller flashes RED, error code F 04 is displayed.
- The app sends a message that the batteries in the Indoor and / or Outdoor humidity/temperature sensor need to be replaced.

• Indoor humidity/temperature sensor

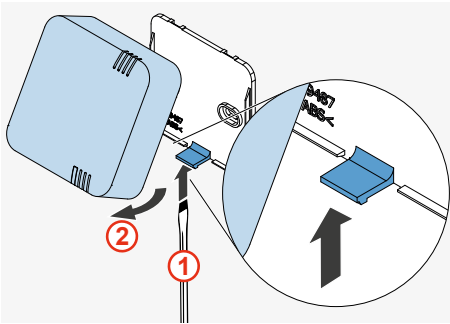

Slotted screwdriver

- ▶ At the bottom, press the latching lever carefully upwards with a suitable tool (e.g. screwdriver) until the housing disengages (1).
- ▶ Lift the upper hooks of the housing out of the eyelets of the base plate and remove the housing from the base plate (2).

⇒ The base plate and housing are separate.

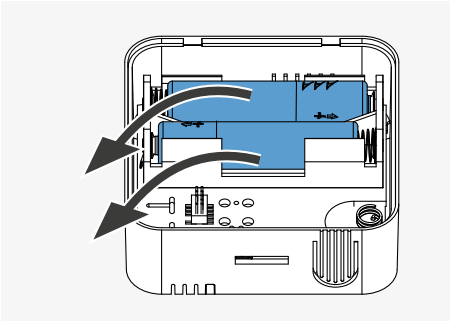

- ▶ Remove the used batteries from the housing's battery compartment and dispose of them properly.



NOTICE: Incorrect polarity of the batteries.

Insert the batteries according to the polarity marked in the housing.

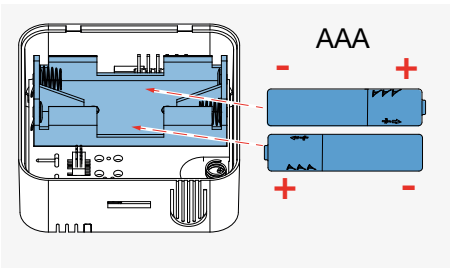

- ▶ Insert the new batteries into the battery compartment in the housing.

⇒ Once the batteries are inserted, the housing can be snapped back into the base plate.

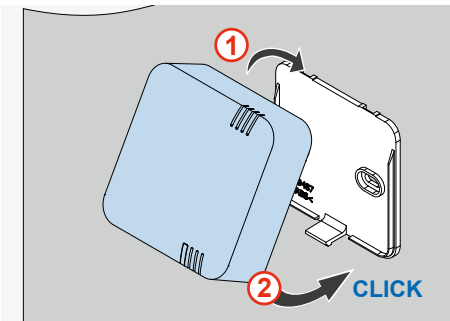

- ▶ Slide the housing from above onto the base plate and hook the hooks of the housing back into the eyelets of the base plate (1).

- ▶ At the bottom, slide the housing over the locking hook and press it gently onto the base plate until it clicks into place (2).

⇒ The batteries have been replaced and the Indoor humidity/temperature sensor has been reinstalled.

• FTS 19 Outdoor humidity / temperature sensor

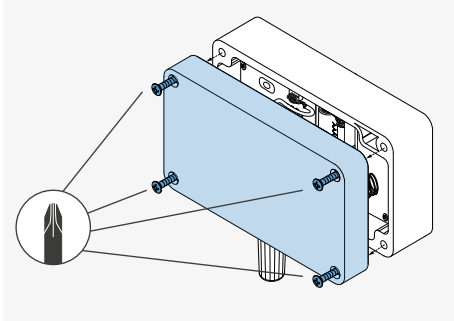

Phillips screwdriver

- ▶ Loosen the 4 screws that fix the cover to the housing.
 - ▶ Remove the cover.
- ⇒ The cover and housing are separate.

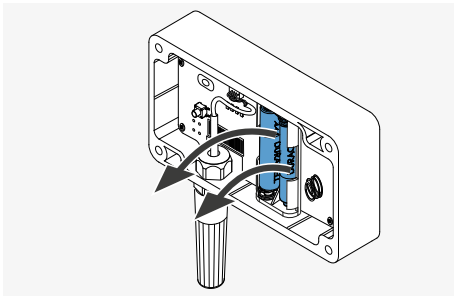

- ▶ Remove the used batteries from the housing's battery compartment and dispose of them properly.

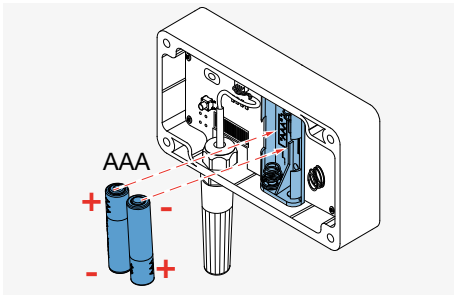

NOTICE: Incorrect polarity of the batteries.

Insert the batteries according to the polarity marked in the housing.

- ▶ Insert the new batteries into the battery compartment in the housing.
- ⇒ Once the batteries are inserted, the housing can be screwed to the cover again.

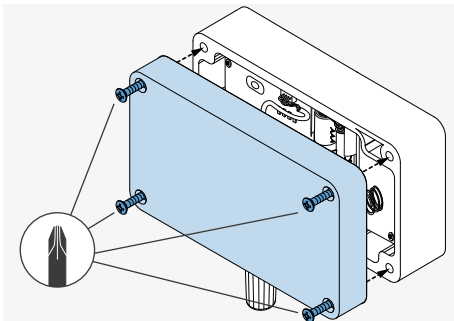

- ▶ Slide the cover onto the housing.
 - ▶ Screw the 4 screws back in to fix the cover to the housing.
- ⇒ The batteries have been replaced and the Outdoor humidity/temperature sensor has been reinstalled.

6 Accessories and spare parts

To order components for your controller, contact your nearest factory representative or our service staff.

Accessories

| Components | Item number |
|---|-------------|
| FTS19-Connect Indoor humidity/temperature sensor | 1003-0125 |
| FTS19-Connect Outdoor humidity/temperature sensor | 1003-0126 |
| CS2-Connect CO ₂ sensor | 1003-0127 |
| SK19-Connect switching contact | 1003-0129 |
| IB Connect V-240x240 dust filter (2x) | 1004-0191 |
| IB Connect V-240x240 pollen filter (2x) | 1004-0195 |
| IB Connect 240x240 activated carbon filter (2x) | 1004-0196 |

Table 10: inVENTer Connect accessories

Spare parts

| Components | Item number |
|--|-------------|
| Easy Connect e16 controller (white) | 1003-0123 |
| IB Connect closing flap, BG, RAL9010 | 3006-0395 |
| IB Connect flush-mounted/surface-mounted housing, R-D160 | 2003-0245 |
| IB Connect flush-mounted/surface-mounted housing, R-D200 | 2003-0246 |

Table 9: inVENTer Connect spare parts

IB = Inner cover

7 Troubleshooting and disposal

Overview

| Fault | Possible cause | Remedy |
|--|---|--|
| Fans not working | Components were not recognised by the controller/ are not paired with the controller. | Pair the component again. |
| | Cable not connected. | Connect the fan cable. |
| Controller does not function | Programming unit is incorrectly/ not connected. | Check wiring. |
| | No electrical contact. | Check cables. Ensure cables are stripped sufficiently (approx. 8.5 mm). |
| Indicator lights do not light up | The respective component, e.g. controller, is defective. | Swap component. |
| | There is no power. | Check power supply. |
| Components are not displayed in the app | No component pairing takes place. | Carry out the pairing of the component with the controller and thereby include it in the controller system (📖 3.3). |
| RED LED flashes on the inner cover | Firmware and hardware check of the inner cover were not successful. | Disconnect the power supply to the inner cover. Restore the power supply after a short break. |
| | | Check the wiring of inner cover electronics, e.g. cable break. |
| RED LED flashes on the controller during commissioning | Firmware and hardware tests of the controller were not successful. | Disconnect the power supply to all devices in the system. Restore the power supply after a short break. The controller restarts commissioning. |

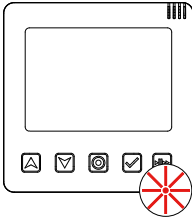

| Fault | Possible cause | Remedy |
|--|--|---|
| <p>The RED and WHITE LEDs flash alternately on the controller, warning symbol.</p>  | F01: Time and date on the controller not set/confirmed. | Set the time again. (📖 2) |
| | F 02: Controller component is no longer accessible. | Check whether the component is switched off. |
| | | Check the radio signal. If the signal is weak, set an amplifier (📖 4.10). |
| | | Check whether the batteries need to be changed (sensor system). |
| | Pair the device with the controller again (📖 3.3) | |
| | F 03: Firmware update failed | Perform the update again (📖 4.7: System update). |
| F 04: Battery status of the sensors low. | Change the batteries (📖 5.3). | |
| F 06: Filter change required | Clean the dust filter or replace it with a new one if necessary (alternatively: pollen or activated carbon filter, 📖 5.2). | |
| F 07: System cleaning required | Clean the components of the ventilation unit (📖 5.2 Operating instructions for your ventilation unit [www.inventer.de/downloads]) | |
| <p>The RED and WHITE LEDs flash alternately on the controller, warning symbol, display screen "PA".</p>  | <p>! NOTICE: If the switching contact was damaged by the safety-relevant limit value being exceeded at the pressure monitor, no troubleshooting has to be carried out on components of the ventilation system. The cause of the negative pressure must be eliminated! If the value falls below the limit value again, all ventilation units restart in the previously set operating mode. All LEDs extinguish.</p> | There is no power. Check power supply. |
| | | Check the radio signal. If the signal is weak, set an amplifier (📖 4.10). |
| LEDs on all inner covers flash alternately RED and GREEN. Inner covers are/will be opened. | | |
| LEDs on the switching contact flash alternately RED and GREEN. | | Pair the device with the controller again (📖 3.3) |
| Sensors without measurement values | Sensors not paired. | Start device pairing (📖 3.3). |

Table 11: Troubleshooting components

If you cannot eliminate the fault, please contact our technical customer service.
You can find information on how to do this in the following section (📖 9: Service).

Dismantling and disposal

Dismantle the controller before disposal.

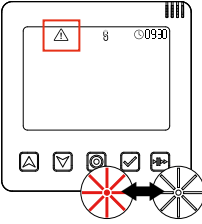
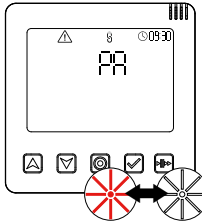

Dispose of the product in compliance with the applicable national regulations. The products described in these operating instructions are largely recyclable due to their low-pollutant processing.

Contact an electronic appliance disposal company to arrange environmentally friendly recycling and disposal of unwanted equipment. Ensure that each product's packaging is sorted correctly for disposal.

| Product | Material | Disposal |
|--|------------------|--|
| Programming unit housing and sensor technology | ABS | Plastic recycling |
| Printed circuit boards | Electronics | Collection point for electrical appliances |
| Housing and inner cover closing flap | PS-SZ / PC | Plastic recycling |
| Batteries (ex works) | Alkali-manganese | Trade collection points |

Table 12: Disposal recommendations for components

8 Warranty and guarantee

Warranty

The warranty refers to the defect-free condition of the product at the time of purchase and covers all defects that were present at the time of purchase. Failure to observe the intended use will invalidate all warranty claims.

Outside Germany, the national warranty provisions of the country in which the system is sold apply. Please contact the distributor for your country.

Manufacturer guarantee

inVENTer GmbH provides a five-year guarantee for electronic components. This covers premature product wear.

Further information about the guarantee is available at www.inventer.de/garantie.

9 Service

Claims

Check the delivery for completeness and transport damage upon receipt using the delivery note. Report missing items immediately, and at the latest within 14 days to your supplier, distributor or factory representative.

Warranty and guarantee claims

In the case of a warranty or guarantee claim, contact your local distributor or factory representative.

In all cases, please return the complete device to the manufacturer.

The warranty is an additional offering by the manufacturer and in no way affects the applicable law.

Accessories and spare parts

To order components for your devices (controller, inner cover, sensor technology, switching contact), contact your factory representative or our service staff.

Technical customer service

For technical support, contact our service staff.











+49 (0) 36427 211-0
 +49 (0) 36427 211-113
info@inventer.de
www.inventer.de

Annex



Ventilation profiles (time intervals of the factory setting)





Living room

 00:00 - 07:59  lvl.:2  [>](#)
 Mon, Tue, Wed, Thur, Fri

 08:00 - 10:59  lvl.:4  [>](#)
 Mon, Tue, Wed, Thur, Fri

 11:00 - 13:59  lvl.:2  [>](#)
 Mon, Tue, Wed, Thur, Fri





 14:00 - 21:59  lvl.:1  [>](#)
 Mon, Tue, Wed, Thur, Fri





 22:00 - 23:59  lvl.:2  [>](#)
 Mon, Tue, Wed, Thur, Fri



 00:00 - 13:59  lvl.:2  [>](#)
 Sat, Sun





 00:00 - 13:59  lvl.:1  [>](#)
 Sat, Sun





Kitchen





 00:00 - 05:59  lvl.:3  [>](#)
 Mon, Tue, Wed, Thur, Fri





 06:00 - 09:59  lvl.:1  [>](#)
 Mon, Tue, Wed, Thur, Fri

 10:00 - 11:59  lvl.:4  [>](#)
 Mon, Tue, Wed, Thur, Fri

 12:00 - 13:59  lvl.:1  [>](#)
 Mon, Tue, Wed, Thur, Fri

 14:00 - 15:59  lvl.:4  [>](#)
 Mon, Tue, Wed, Thur, Fri

 16:00 - 22:59  lvl.:1  [>](#)
 Mon, Tue, Wed, Thur, Fri

 23:00 - 23:59  lvl.:3  [>](#)
 Mon, Tue, Wed, Thur, Fri

 00:00 - 05:59  lvl.:3  [>](#)
 Sat, Sun





















































 06:00 - 13:59  lvl.:1  [>](#)
 Sat, Sun

 14:00 - 15:59  lvl.:3  [>](#)
 Sat, Sun





































 16:00 - 22:59  lvl.:1  [>](#)
 Sat, Sun

 23:00 - 23:59  lvl.:3  [>](#)
 Sat, Sun





Bedroom





| | | | | |
|---|--------------------------|--|---|---|
|  | 00:00 - 08:59 |  lvl.:1 |  | > |
|  | Mon, Tue, Wed, Thur, Fri | | | |
|  | 09:00 - 10:59 |  lvl.:4 |  | > |
|  | Mon, Tue, Wed, Thur, Fri | | | |
|  | 11:00 - 16:59 |  lvl.:2 |  | > |
|  | Mon, Tue, Wed, Thur, Fri | | | |
|  | 17:00 - 18:59 |  lvl.:3 |  | > |
|  | Mon, Tue, Wed, Thur, Fri | | | |
|  | 19:00 - 20:59 |  lvl.:1 |  | > |
|  | Mon, Tue, Wed, Thur, Fri | | | |
|  | 21:00 - 23:59 |  |  | > |
|  | Mon, Tue, Wed, Thur, Fri | | | |
|  | 00:00 - 00:59 |  |  | > |
|  | Sat, Sun | | | |
|  | 01:00 - 11:59 |  lvl.:1 |  | > |
|  | Sat, Sun | | | |
|  | 12:00 - 13:59 |  lvl.:3 |  | > |
|  | Sat, Sun | | | |
|  | 14:00 - 16:59 |  lvl.:2 |  | > |
|  | Sat, Sun | | | |
|  | 17:00 - 18:59 |  lvl.:3 |  | > |
|  | Sat, Sun | | | |
|  | 19:00 - 21:59 |  lvl.:1 |  | > |
|  | Sat, Sun | | | |
|  | 22:00 - 23:59 |  |  | > |
|  | Sat, Sun | | | |





Children's room





| | | | | |
|---|--------------------------|--|--|---|
|  | 00:00 - 08:59 |  lvl.:1 |  | > |
|  | Mon, Tue, Wed, Thur, Fri | | | |
|  | 09:00 - 11:59 |  lvl.:4 |  | > |
|  | Mon, Tue, Wed, Thur, Fri | | | |
|  | 12:00 - 18:59 |  lvl.:2 |  | > |
|  | Mon, Tue, Wed, Thur, Fri | | | |
|  | 19:00 - 21:59 |  |  | > |
|  | Mon, Tue, Wed, Thur, Fri | | | |
|  | 22:00 - 23:59 |  lvl.:1 |  | > |
|  | Mon, Tue, Wed, Thur, Fri | | | |
|  | 00:00 - 11:59 |  lvl.:1 |  | > |
|  | Sat, Sun | | | |
|  | 12:00 - 19:59 |  lvl.:2 |  | > |
|  | Sat, Sun | | | |
|  | 20:00 - 22:59 |  |  | > |
|  | Sat, Sun | | | |
|  | 23:00 - 23:59 |  lvl.:1 |  | > |
|  | Sat, Sun | | | |





Bathroom





 00:00 - 05:59  lvl.:3  
 Mon, Tue, Wed, Thur, Fri

 06:00 - 8:59  lvl.:1  
 Mon, Tue, Wed, Thur, Fri

 09:00 - 11:59  lvl.:4  
 Mon, Tue, Wed, Thur, Fri

 12:00 - 17:59  lvl.:2  
 Mon, Tue, Wed, Thur, Fri

 18:00 - 22:59  lvl.:1  
 Mon, Tue, Wed, Thur, Fri

 23:00 - 23:59  lvl.:3  
 Mon, Tue, Wed, Thur, Fri





 00:00 - 07:59  lvl.:3 
 Sat, Sun





 08:00 - 11:59  lvl.:1 
 Sat, Sun





 12:00 - 17:59  lvl.:2 
 Sat, Sun





 18:00 - 23:59  lvl.:1 
 Sat, Sun





Holiday

 00:00 - 07:59  lvl.:1  
 Mon, Tue, Wed, Thur, Fri, Sat, Sun

 08:00 - 09:59  lvl.:4  
 Mon, Tue, Wed, Thur, Fri, Sat, Sun

 10:00 - 19:59  lvl.:1  
 Mon, Tue, Wed, Thur, Fri, Sat, Sun

 20:00 - 21:59   
 Mon, Tue, Wed, Thur, Fri, Sat, Sun

 22:00 - 23:59  lvl.:1  
 Mon, Tue, Wed, Thur, Fri, Sat, Sun

Automatic ventilation profiles

The automatic ventilation profiles do not follow a 7-day timer and cannot be programmed by the user. With these ventilation profiles, ventilation behaviour is determined by temperature and humidity variables in two environments (inside the usage unit and outside). An outdoor sensor (Outdoor humidity/temperature sensor) is therefore absolutely essential for all automatic ventilation profiles.

To be able to use the cellar ventilation profiles, an Indoor humidity/temperature sensor, CO₂ sensor or controller in the cellar ventilation zone is also required.

The automatic ventilation profiles are:

- **Summer mode**



This ventilation profile can be used during the warm season for the desired ventilation zone(s). There is then a constant comparison of the outdoor and indoor temperatures. Based on the temperature values, the system automatically decides whether the indoor climate should be maintained or whether "passive cooling" should be carried out with the ventilation function. After the end of the warm period, the summer mode should be replaced by a different ventilation profile. To prevent accidental operation outside summer time, the automatic ventilation function is only activated when the outdoor temperature exceeds 16 °C.

- **Cellar ventilation**



This ventilation profile works without heat recovery and is suitable for unheated cellars and storage rooms. The aim is to prevent mould by specifically regulating the moisture content of the room air. With cellar ventilation, automatic dew point control is achieved by continuously comparing the absolute humidity and temperature values of outdoor air and cellar room air. Based on these values, the system automatically calculates the ideal times to remove moisture via the ventilation function. If, on the other hand, there is a risk of moisture ingress from the outside, the system pauses and closes the automatic closing flaps. The closed flaps prevent a passive inflow of moisture-laden outdoor air.

- **Cellar ventilation with heat recovery (HR)**



This ventilation profile works with heat recovery and is suitable for all heated rooms below ground level. The aim is to prevent mould by specifically regulating the moisture content of the room air. With cellar ventilation, automatic dew point control is achieved by continuously comparing the absolute humidity and temperature values of outdoor air and cellar room air. Based on these values, the system automatically calculates the most suitable ventilation level and switches automatically between heat recovery and ventilation depending on environmental conditions. If there is a risk of moisture ingress from the outside, the system pauses and closes the automatic closing flaps. The closed flaps prevent a passive inflow of moisture-laden outdoor air.

inVENTer GmbH
Ortsstraße 4a
D-07751 Löberschütz
Germany
www.inventer.eu

Subject to modifications.
We accept no liability for printing errors.

Item number: 5022-0009
Version: 1.1 – 08/2021

